Wood Seating Specification Guide

What's New?

What's New information is now available on the in2.steelcase.com Web site. Go to *What's New*, then *Show News by Category*, then *Incentives, Pricing, Promotions*.

► See the *Specification Guide Library: Reference Guide* for information about where to find products.

Availability

Electronic price list updated with release 158.C (U.S.) and 135.C (Canada), dated July 19, 2004.

► For a list of all trademarks, refer to the last page of this specification guide.



For Canadian Pricing

Calculate in the following order to avoid rounding errors:

- Multiply the base price and each option by 1.38.
- Round each to the nearest dollar.
- Add base and options for total list price.

Working With This Specification Guide

Statement of Line	2
Guidelines for Selecting Appropriate Ergonomic Seating	12
Basics of Ergonomic Seating	13
Basics of Adjustability	14
Additional Resources	15

Product Information

Executive Seating	17
General-Use Seating	43
Guest Seating	55
Stackable Seating	93
Lounge Seating	105

Surface Materials

Surface Materials	136
Wood Seating Upholstery Matrix	140
Designtex Graded-In Wood Seating Upholstery Matrix	141
Fire Code Wood Seating Upholstery Matrix	142
Fire Code Wood Seating Upholstery Matrix for Designtex	143
Fire Code Seating (FCS) Exceptions for Wood Seating	144
Fire Code Seating with COM	145
Wood Color Availability Matrix	146
Guidelines for Directional Fabrics	147

Resources

149

Wood Seating

Statement of Line

Executive Seating

Breton

Understanding
▶ Page 18
Specifying
▶ Pages 20–21



Executive High-Back Desk Chair



Conference Mid-Back Chair

Collegium

Understanding
▶ Page 22
Specifying
▶ Page 24



High-Back Desk Chair with Enclosed Arms



High-Back Desk Chair with Open Arms



Mid-Back Desk Chair with Enclosed Arms



Mid-Back Desk Chair with Open Arms

Decorum

Understanding
▶ Page 26
Specifying
▶ Page 28



High-Back Desk Chair with Enclosed Arms



High-Back Desk Chair with Open Arms



Mid-Back Desk Chair with Enclosed Arms



Mid-Back Desk Chair with Open Arms

Mansfield

Understanding
▶ Page 30
Specifying
▶ Page 32

Understanding
▶ Page 72
Specifying
▶ Pages 74–75



High-Back
Desk Chair



Mid-Back
Desk Chair

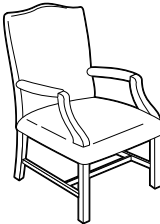

Upholstered
Guest Chair



Wood
Guest Chair

Masque

Understanding
▶ Page 34
Specifying
▶ Page 36



High-Back
Desk Chair

Theorem

Understanding
▶ Page 38
Specifying
▶ Page 40



High-Back
Desk Chair with
Enclosed Arms



Mid-Back
Desk Chair with
Enclosed Arms

General-Use Seating

Ascot

Understanding
▶ Page 44
Specifying
▶ Page 46



High-Back
Desk Chair with
Open Arms



High-Back
Desk Chair with
Enclosed Arms



Low-Back
Desk Chair with
Open Arms



Low-Back
Desk Chair with
Enclosed Arms

Gentry

Understanding
▶ Page 48
Specifying
▶ Pages 50–53



High-Back
Desk Chair with
Enclosed Arms



High-Back
Desk Chair with
Open Arms



Low-Back
Desk Chair with
Enclosed Arms



Low-Back
Desk Chair with
Open Wood Arms



Low-Back
Desk Chair with
Open Thermoplastic Arms



Low-Back
Guest Chair

Understanding
▶ Page 70
Specifying
▶ Page 71

Guest Seating

Alcove

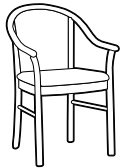

Guest Chair with Open Arms

Understanding
▶ Page 56
Specifying
▶ Page 57

Alerion



Upholstered-Back Guest Chair



Spindle-Back Guest Chair

Understanding
▶ Page 58
Specifying
▶ Page 59

Collaboration



Open

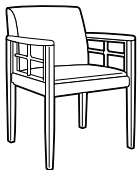

Mullion



Arcade



Eyelet

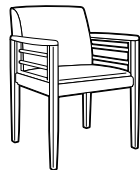

Ladder

Understanding
▶ Page 60
Specifying
▶ Page 62



Reveal



Upholstered Insert

Tip: All Collaboration guest chairs are available with plain wood arms or with upholstered arm caps.

England

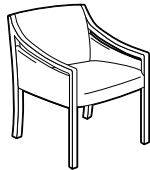

Guest Chair with Enclosed Arms

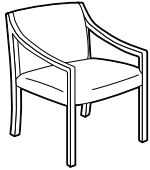

Guest Chair with Open Arms

Understanding
▶ Page 64
Specifying
▶ Page 65

Escapade



Guest Chair with Wood Slat Back



Guest Chair with Upholstered Back

Understanding
▶ Page 66
Specifying
▶ Page 68

Gentry

Understanding
 ▶ Page 70
 Specifying
 ▶ Page 71



Low-Back Guest Chair

Mansfield

Understanding
 ▶ Page 72
 Specifying
 ▶ Pages 74–75

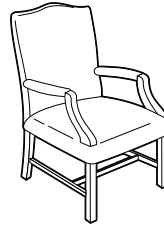

Upholstered Guest Chair



Wood Guest Chair

Mingle

Understanding
 ▶ Page 76
 Specifying
 ▶ Page 78

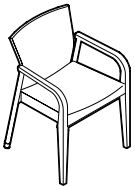

Guest Chair

Oriana

Understanding
 ▶ Page 80
 Specifying
 ▶ Page 81



Vertical Slat-Back Guest Chair



Horizontal Slat-Back Guest Chair

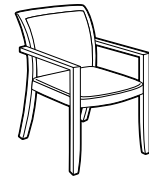

Fully Upholstered Back Guest Chair

Snodgrass

Understanding
 ▶ Page 82
 Specifying
 ▶ Page 84

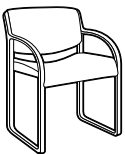

Guest Chair with Open Back and Open Arms

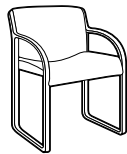

Guest Chair with Full Back and Open Arms

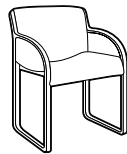

Guest Chair with Full Back and Enclosed Arms



Guest Chair with Open Back without Arms



Guest Chair with Full Back without Arms

Terrazzo

Understanding
▶ Page 86
Specifying
▶ Page 88

Topaz

Understanding
▶ Page 90
Specifying
▶ Page 92



Guest Chair with Square Lattice Back



Guest Chair with MacIntosh Lattice Back



Guest Chair with Horizontal Lattice Back



Guest Chair with Closed Back

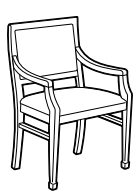

Guest Chair with Open Back

Stackable Seating

Company

Understanding
▶ Page 94
Specifying
▶ Page 96

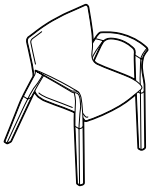

Stacking Guest Chair
with Upholstered Back
and Seat

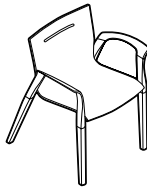

Stacking Guest
Chair with
Wood Back
and Seat

Deck

Understanding
▶ Page 98
Specifying
▶ Pages 100–104



Stacking Guest Chair
with Arms

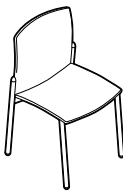

Stacking Guest Chair
without Arms

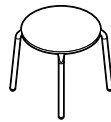

Occasional Table

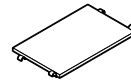

In-Line Table



Stool

Lounge Seating

Community Lounge

- ▶ Understanding
▶ Page 106
- ▶ Specifying
▶ Page 108

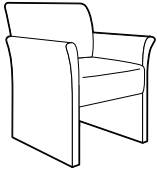

Club Chair

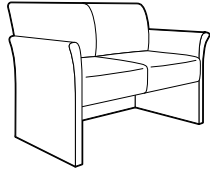

Settee

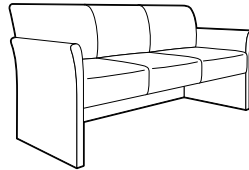

Sofa

Dearborn Lounge

- ▶ Understanding
▶ Page 110
- ▶ Specifying
▶ Pages 111–112

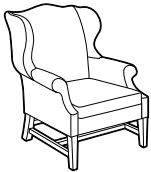

Wing Chair

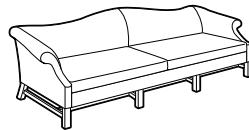

Camelback Sofa

Étude

- ▶ Understanding
▶ Page 114
- ▶ Specifying
▶ Pages 116–117



Club Chair

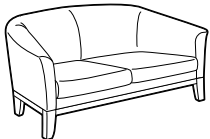

Love Seat

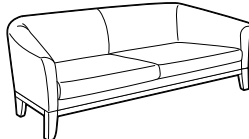

Sofa

Groove

Understanding
▶ Page 118
Specifying
▶ Pages 122–134

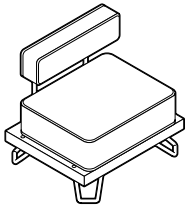

Chair with Block Back

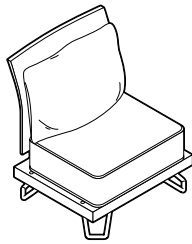

Chair with Sail Back

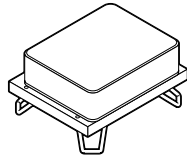

Ottoman

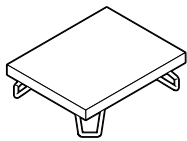
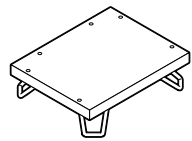

Table without Grommets



Table

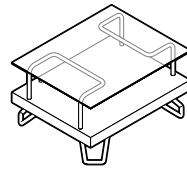

Table with Top

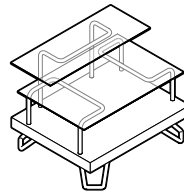

Table with Top and Shelf

Guidelines for Selecting Appropriate Ergonomic Seating

<p>General-Use</p>	<p>High Interaction Low</p>	<p>General-Use Seating</p> <p>Group Communicating Group Collaborating</p> <hr/> <p>High-Performance Seating</p> <p>Individual Processing (task intensive) Individual Analyzing/Creating (multi-task)</p>	<ul style="list-style-type: none"> • Short periods of sitting • Moderate computer use • In some cases, a general-use chair can be used for short-term, individual analyzing/creating. 	
<p>High-Performance</p>			<ul style="list-style-type: none"> • Long periods of sitting • Heavy computer use • The more repetitive the task (individual processing work), the more critical it is to have a high-performance chair with full adjustability. 	
<p>Executive</p>		<p>Executive Seating</p>	<p>Today's executive is an active participant, not just a delegator. Image is very important in the executive suite, but time at the computer must also be a consideration. Whether image or ergonomics drive the choice, this range of seating is diverse to provide the perfect chair for any executive work setting.</p>	<ul style="list-style-type: none"> • Design that acknowledges image • Aesthetics and detailing that suit the setting • Ergonomic features matched to the kinds of work
<p>Guest</p>		<p>Guest Seating</p>	<p>Guest seating must be adaptable to many roles: as side chairs, pulled up to the conference table, in the learning center, in the private office, or in high-traffic areas where long use-life is essential. Guest seating is not intended for long periods of seated work, but must provide short-term comfort and have a welcoming, comfortable look.</p>	<ul style="list-style-type: none"> • A style in harmony with the other furniture • A scale that suits the environment • A durability that fits the intended use
<p>Stackable</p>		<p>Stackable Seating</p>	<p>Stackable seating is used when occasional, transportable, easy-to-store seating is needed. Whether used as side chairs, meeting chairs, in classrooms, or cafeterias, the challenge is to maintain an excellent aesthetic combined with great strength even though the chairs are light in scale for portability.</p>	<ul style="list-style-type: none"> • Durability for high-volume, high-traffic use • Light weight for easy stacking and moving • Extra features if needed, such as tablet arms, bookracks, glides, transport and storage dollies, and ganging or alignment devices.
<p>Lounge</p>		<p>Lounge Seating</p>	<p>Lounge seating is often multiple and is found throughout the organization from reception areas to executive offices. The selection is the broadest of any of our categories, ranging from traditional leather sofas to school and hospital seating. Lounge seating is the "first impression seating," critical to an organization's image.</p>	<ul style="list-style-type: none"> • Durability related to level of use • A design that looks right in multiples • Size, scale, and appearance that suits the environment

Basics of Ergonomic Seating

Proper ergonomic seating can help workers perform more efficiently and avoid muscle and eye strain.

Neck is straight or slightly forward.

Shoulders are relaxed so arms hang naturally.

Back has full contact with the backrest (sit all the way back in your chair).

Elbows and forearms can rest comfortably on the arms of your chair, or on worksurfaces that are used for writing, paperwork, and other tasks.

Lower back fits into curved lumbar support.

Tension is adjusted so backrest tilts easily, yet provides smooth, even support.

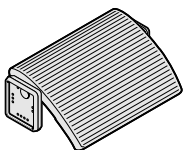

If worksurfaces and keyboard support are not height-adjustable, raise your chair's seat height to achieve the appropriate relationship to your tasks. If this leaves your feet dangling above the floor, use a Details footrest.

Call Details, 1.800.833.0411, or your Steelcase dealer, for additional information or price list.

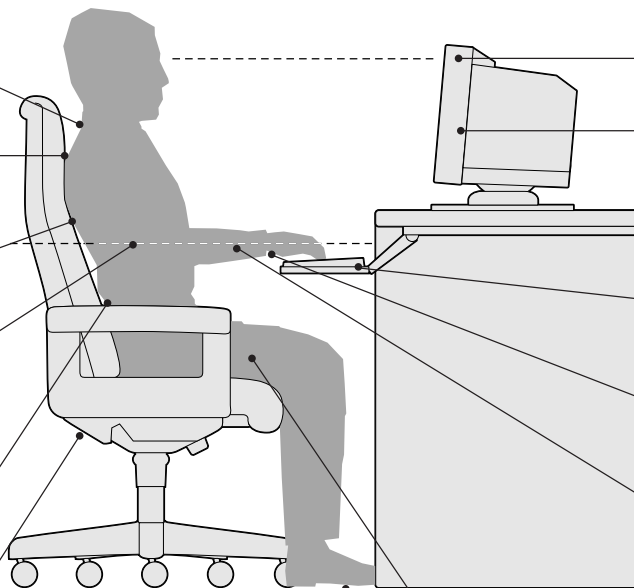

Top of monitor should be at eye level.

Screen is 20 to 30 inches from the eyes.

Screen is at eye level or slightly lower and directly in front of worker so head is not turned.

Keyboard is at elbow height.

Wrists should be straight when keying or mousing, not bent up or down.

When keying or mousing, forearms are parallel to the floor.

Thighs are parallel to the floor.

Feet are flat on the floor or on a footrest.

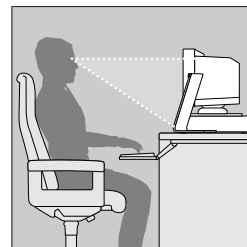

Keep frequently viewed objects, such as a VDT or source document, at or below the horizontal line of sight. Arrange display screen and documents to be equidistant from your eyes.

ANSI/HFES is the American National Standards Institute/Human Factors & Ergonomics Society. This organization's 1988 guidelines cover the ergonomic needs of task workers. These guidelines are currently under revision.

ANSI/BIFMA is the American National Standards Institute/Business and Institutional Furniture Manufacturer's Association. All Steelcase furniture meets or exceeds ANSI/ BIFMA standards for structural quality.

Basics of Adjustability

Steelcase chairs offer varying levels of adjustability to meet the needs of many types of users. Adjustable chairs may offer one or more of these features:



Synchro-tilt feature means the chair back and seat are synchronized to move in a 2:1 ratio. When the user leans back, the seat rises only half as much, allowing the user's feet to remain flat on the floor.



Advanced swivel-tilt feature incorporates a no front-rise design that allows the seat to remain level even when the user leans back.



Swivel-tilt feature means the chair back and seat are fixed together and move in unison. When the user leans back, the seat rises so that the back-to-seat angle remains constant.



Knee-tilt (low front rise) minimizes the rise of the front of the seat when the chair is in a reclined position, allowing the user's feet to remain on the floor. This feature reduces pressure under the thighs, allowing for continuous blood circulation.



Swivel feature allows the user to rotate the seat 360 degrees in either direction.



Pneumatic-height adjustment allows the user to remain seated while adjusting the seat height by way of a control button or lever.



Manual-height adjustment allows the user to raise and lower seat height by spinning the seat while keeping the base stationary. Cannot be done from seated position.

Seat-angle adjustment allows the user to change the angle of the seat to a forward position. Available on Gentry knee-tilt models only.



Back-tension adjustment allows the user to control the amount of resistance felt when leaning back in the chair.



Variable back stop allows the user to lock the back upright and to preset their range of recline.



Variable back lock allows the user to lock and unlock the backrest in any position within the tilt range.



Upright back lock allows the user to lock the backrest in a full upright position or release it for full tilt motion.

Wood seating products are supported with an array of informational materials, tools, and software to help you plan an installation efficiently.

Product brochures and planning tools can be ordered through your Steelcase area office, by calling 1.800.784.0355, or through the Steelcase Marketing Communications Web site at in2.steelcase.com.

Product Brochures

The following publications focus on specific wood seating in greater detail:

Alcove

Form number S3012

Alerion

Form number S11075

Ascot

Form number S2773

Breton

Form number S2651

Collaboration

Form number S11078

Collegium/Theorem/Decorum

Form number S11071

Community Lounge

Form number S2763

Company

Form number S11197

Deck

Form number S11198

Etude

Form number S11072

England

Form number S3007

Escapade

Form number S11074

Gentry

Form number S11076

Groove

Form number S11544

Masque

Form number S11093

Mingle

Form number S10880

Oriana

Form number S11079

Terrazzo

Form number S10886

Topaz

Form number S11077

Traditional Brochure

Form number S11196

Steelcase Inc. Corporate Capabilities Brochure

This publication offers a concise overview of Steelcase including insights into the attitudes and commitments that make the corporation unique. In addition, the brochure provides an illustrated listing of all the products and services offered and international activities are described.
Form number S5203
Updated 4/95

Planning Tools

Quick Delivery Handbook

This handbook describes all Steelcase, Turnstone, Details, and Steelcase Design Partnership products that are available for 3-Day (3-day shipment), Express12 (12-day delivery), or 15-Day (15-day shipment).

Smart Stuff Catalog

This collection of basic products is ideal for a buyer working within a tight budget. Included in the Smart Stuff Catalog are many seating and casegoods products from Cane-Creek, as well as other Steelcase products.
Form number S2557

Chairs for People at Work

This full-color, seating overview divides chairs into two categories—work chairs and multi-use chairs. Brochure also includes a four-page fold out that contains a visual index and shows customers, at a glance, the array of choices Steelcase offers.
Form number S11347

Casegoods and Seating Delivered in 12 Days

A comprehensive collection of “wood” casegoods and seating products available for 12-day delivery.
Form number S3461

Surface Materials

Surface Materials Reference Manual

This publication provides:

- An explanation of the surface materials and their categories
- “Available on” matrices
- Vertical surface fabric and seating upholstery selection listing
- Pricing for surface materials
- Technical data for surface materials
- Surface material care and cleaning instructions

Additional surface materials specification tools

are available to assist you in the specification process—the Surface Materials Binders and the Surface Materials Tool Box.

Surface Materials Finishes Binder

- includes:
- Surface Materials Reference Manual
 - A complete set of swatch cards for hard surfaces

Surface Materials Vertical Surface Fabric Binder

- includes:
- A complete set of swatch cards for vertical surface fabric

Surface Materials Seating Upholstery Binder

- includes:
- Designtex Graded-In Catalog
 - A complete set of swatch cards for seating upholstery

Surface Materials Tool Box

provides 3" x 3" samples of the following surface materials:

- Vertical surface fabric
- Seating upholstery
- Wood veneer
- Paint
- Laminate

Form number S8150

Customer's Own Material (COM) Web site

features fabric test results for all COM fabrics which have been tested by Steelcase and also allows you to calculate yardage requirements for most Steelcase seating lines. The Web site will always contain the most current information available, providing the same information you would receive if you called or faxed a COM Consultant. To locate the COM Web site:

- Visit www.steelcase.com
- Click on "Knowledge & Design"
- Select "Customer's Own Material"

Computer Tools

Electronic Catalog

Accurate sales quotations and purchase orders for Steelcase products are created with specification software that uses Steelcase Electronic Catalog data. Use the data to specify and price style numbers and options for every Steelcase product. The data is updated quarterly by Steelcase and provided to software programs like the Hedberg Business System, 20-20 CAP Studio, and 20-20 Office Sales.

Furniture Symbol Graphic Data

Steelcase creates 2D and 3D furniture symbols (with attributes) for planning and initially specifying Steelcase products. This data is incorporated into several add-on software packages that work in either a Microstation or an AutoCAD drafting environment.

For more information on these and other software tools to help you plan effective work environments, please contact Steelcase eTools at 1.616.246.9542.



Product Info

Electronic versions of this and many other specification guides in Acrobat PDF (Portable Document Format) allow you to scan, search, and print any page on virtually any computer. You can access these files at the Steelcase.com Web site or My Sales Online at in2.Steelcase.com.

Support

Steelcase Capabilities

Steelcase products are distributed, installed, and serviced through a network of more than 600 dealers worldwide. Steelcase is also represented with offices and corporate showrooms in 26 U.S. cities, 4 Canadian cities, and in France, Germany, Great Britain, and Japan. Every Steelcase product meets our exceptionally high standards of quality and durability and comes with the Steelcase assurance of excellence in service.

For assistance, please call your local dealer, the Steelcase Solutions Resource Team, or the Steelcase Solutions Fulfilled Team at 1.888.STEELCASE (1.888.783.3522).

Call the Steelcase Solutions Resource Team prior to placing an order, when working on a bid, or when you need information about product applications and specifications.

Call the Steelcase Solutions Fulfilled Team if you have submitted an order to Steelcase and you need to speak to your service representative about the order. Also call if you have any post-shipment quality or warranty concerns or service parts questions.

Outside the U.S.A., Canada, Mexico, Puerto Rico, and the U.S. Virgin Islands, call 1.616.247.2500.

For information about Steelcase, the name of your nearest Steelcase dealer, or for product literature, call 1.800.333.9939 or visit our Web site: www.steelcase.com.

Executive Seating

Breton	18
Collegium	22
Decorum	26
Mansfield	30
Masque	34
Theorem	38

Breton

Breton chairs, designed by David Jenkins, combine ergonomic comfort with elegance and fine craftsmanship for executive offices and conference room settings.

Handcrafted leather upholstery is standard.

Upholstered arms are enclosed.

Seat height adjusts from 18¾"H to 21¼"H; pneumatic-adjustment mechanism is standard on executive models.

Five-arm metal base is black with maple wood base caps.



Interlocking cushions flex independently to cradle every motion.

Hard dual-wheel casters are provided for use on carpet. Soft dual-wheel casters are available for use on hard floors or chair mats.

Product Details



High- and mid-back models are available for executive applications. Conference seating is available in mid-back models only.

Coordinated articulation in seat and back provides balanced support through the work day.

Optional perforated leather seat and back add ventilated comfort.

Contoured foam backrest, on conference models only, provides lumbar support.

Actual Dimensions

	High-Back Desk Chairs	Mid-Back Desk Chairs	Conference Chairs
Overall depth	26¾"	27½"	27½"
Overall width	27¼"	27¼"	27¼"
Overall height	42"–44½"	38"–40½"	38"
Seat depth	19"	19"	19"
Seat width	19"	19"	19"
Back width	26¾"	26¾"	26¾"
Back height	25⅝"	21½"	21½"
Width between arms	19"	19"	19"
Seat to floor height	18¾"–21¼"	18¾"–21¼"	18¾"
Arm height from floor	25"–27½"	25"–27½"	25¾"

Adjustability Features

- Pneumatic height (standard on Executive models)
- Variable-position back lock
- Back tension control
- Synchro-tilt mechanism

Adjustment Features

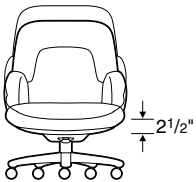

Pneumatic-seat adjustment, standard on executive models only, permits push-button height control. To lower, pull lever on right side while seated. To raise, pull lever and lift your weight off the chair.



Variable position back lock locks at various tilt angles, including fully upright. To set back angle and back tilt, push the back of button and lean back to desired position. Release button to lock back. Push the front of the button to release the back for free movement.

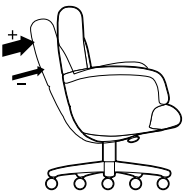

Back tension control varies reclining back support from light to firm and adjusts by turning knob. Turn knob clockwise to decrease tension, counterclockwise to increase.

Tip: Be sure to unlock (release) the variable back stop before adjusting the back tension.

Synchro-tilt mechanism provides synchronized back movement while feet remain flat on the floor.

Surface Materials

Seat, back, and arms

- Leather
- Customer's Own Leather (option)
- Perforated leather (option on insert)

Column

- Black metal only

Base

- Black metal with maple wood base caps
- Customiz stain on wood (option)

Casters

- Black only

Programs & Services

▶ See the *Surface Materials Reference Manual* for further detail about programs and services offered for seating.

The Customer's Own Material (COM) Program

offers the opportunity for customers to select fabrics that are not offered through the standard Steelcase surface materials program for use on Steelcase products. Through the COM program, Steelcase will test your materials for application on Steelcase products. Once approved, you can place your order. Steelcase will facilitate the entire ordering process and give you a production schedule. Steelcase will order the COM fabric directly from the textile manufacturer. For up-to-date information regarding fabric test results for all COM fabrics and details regarding yardage requirements for most Seating lines, visit the COM Web site. To locate the COM Web site:

- Visit www.steelcase.com
- Click on "Knowledge & Design"
- Select "Customer's Own Material"

Soil-retardant treatment is not available.

Fire Code Seating (FCS) modification is not available.

Local codes may have special requirements for upholstery.

Resources

Breton Brochure
Form number S2651

Chairs for People at Work
Form number S11347

Breton Executive Desk Chairs



Standard Includes		Required to Specify
<ul style="list-style-type: none"> ▶ Need help? Product details, page 18 	<ul style="list-style-type: none"> • Back tension control • Variable-position back lock • Pneumatic-height adjustment • Upholstery: leather • Five-arm base and column: black metal with wood base caps • 2"-diameter, hard-composition, dual-wheel casters: black only 	<ol style="list-style-type: none"> 1 Style number 2 Leather color number for upholstery 3 Color number for base: <ul style="list-style-type: none"> – 6205 Black base with maple base caps (specify wood color number) 4 Options, if selected (see below) <ul style="list-style-type: none"> ▶ See <i>Surface Materials</i>, page 136.

	Options	U.S. Price	Required to Specify
Surface Materials	Upholstery <ul style="list-style-type: none"> • Perforation of leather seat and back 	+\$65	Add suffix P to the style number and specify leather color number.
	Base <ul style="list-style-type: none"> • Customiz stain on wood base 	+\$24	Specify with <i>Customiz stain</i> . ▶ See <i>Surface Materials Reference Manual</i> .
Casters	<ul style="list-style-type: none"> • 2"-diameter, soft, dual-wheel 	+\$18	Specify with soft casters.

Specification Information



Description	Style Number	U.S. Base Price
		COL : Steelcase : Leather

High-Back

Wood base caps	497187MW	\$5460	+\$606
----------------	-----------------	--------	--------



Description	Style Number	U.S. Base Price
		COL : Steelcase : Leather

Mid-Back

Wood base caps	497147MW	\$5140	+\$564
----------------	-----------------	--------	--------



For Canadian Pricing
Multiply U.S. Price by 1.38.
▶ See page 1 for details.



Standard Includes		Required to Specify
<ul style="list-style-type: none"> ▶ Need help? Product details, page 18 	<ul style="list-style-type: none"> • Back tension control • Variable-position back lock • Fixed height • Contoured foam backrest for lumbar support • Upholstery: leather • Five-arm base and column: black metal with wood base caps • 2"-diameter, hard-composition, dual-wheel casters: black only 	<ol style="list-style-type: none"> 1 Style number 2 Leather color number for upholstery 3 Color number for base: <ul style="list-style-type: none"> – 6205 Black base with maple base caps (specify wood color number) 4 Options, if selected (see below) <ul style="list-style-type: none"> ▶ See <i>Surface Materials</i>, page 136.

Options	U.S. Price	Required to Specify
Surface Materials Upholstery <ul style="list-style-type: none"> • Perforation of leather seat and back 	+\$65	Add suffix P to the style number and specify leather color number.
Base <ul style="list-style-type: none"> • Customiz stain on wood base 	+\$24	Specify with <i>Customiz stain</i> . ▶ See <i>Surface Materials Reference Manual</i> .
Casters <ul style="list-style-type: none"> • 2"-diameter, soft, dual-wheel 	+\$18	Specify with <i>soft casters</i> .

Specification Information



Description	Style Number	U.S. Base Price
		COL : Steelcase : Leather

Mid-Back with Casters

Wood base caps	497647MW	\$4806	+\$564
----------------	-----------------	--------	--------



For Canadian Pricing
 Multiply U.S. Price by 1.38.
 ▶ See page 1 for details.

Collegium

Collegium chairs, designed by Arnie Dammermann, feature contemporary styling that compliments a variety of office environments.

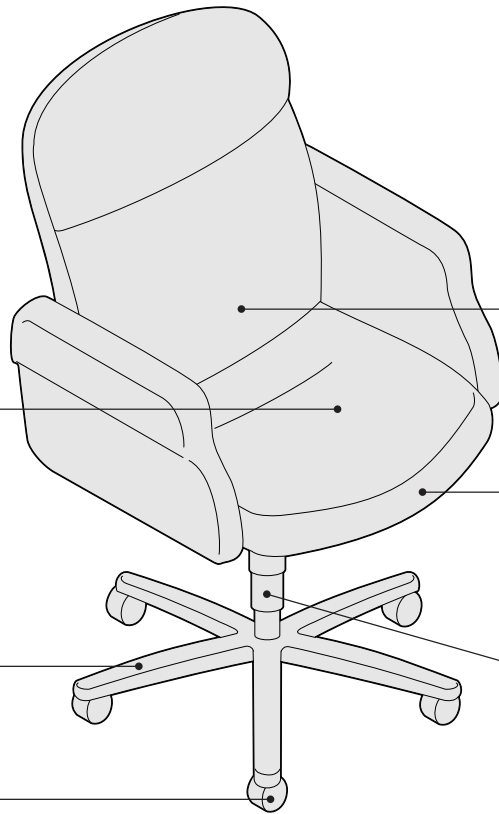

Seat height adjusts from 16"H to 21 1/2"H and is available with manual or pneumatic adjustment mechanism.

Five-arm base is standard in black aluminum. Solid maple base caps are optional.

Hard dual-wheel casters are provided for use on carpet. Soft dual-wheel casters are available for use on hard floors or chair mats.

Lumbar contours provide lower back support.

Waterfall front edge eases pressure under user's legs and enhances circulation.

Synchro-tilt mechanism

Product Details



High-back and mid-back models feature gently rounded contours and a sculptured silhouette.



Arms are either enclosed upholstered or open upholstered with hardwood trim.

Extended-depth seat option, at 17 1/2"D, adds 1 1/2" to accommodate longer legs.

All Collegium chairs comply with ANSI/HFS and BIFMA standards.

Exception: The extended seat option exceeds ANSI/HFS seat depth restrictions.

Optional perforated leather seat and back add ventilated comfort.

Actual Dimensions

	High-Back Desk Chairs		Mid-Back Desk Chairs	
	Open arms	Enclosed arms	Open arms	Enclosed arms
Overall depth	25 1/2"	25 1/2"	25 1/2"	25 1/2"
Overall width	27"	27"	27"	27"
Overall height	45"–50 1/2"	45"–50 1/2"	40"–45 1/2"	40"–45 1/2"
Seat depth	16"	16"	16"	16"
Seat width	20 1/8"	20 1/8"	20 1/8"	20 1/8"
Back width	20 1/8"	20 1/8"	20 1/8"	20 1/8"
Back height	30"	30"	25"	25"
Width between arms	20"	20"	20"	20"
Seat to floor height	16"–21 1/2"	16"–21 1/2"	16"–21 1/2"	16"–21 1/2"
Arm height from floor	24"–29 1/2"	24 1/4"–29 3/4"	24"–29 1/2"	24 1/4"–29 3/4"

Adjustability Features

- Manual height
- Pneumatic height
- Variable back stop
- Back tension control
- Synchro-tilt mechanism

Adjustment Features

Synchro-tilt mechanism provides synchronized back movement while feet remain flat on floor.

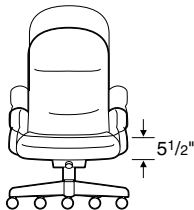

Manual-height adjustment is standard. Rotating the unoccupied chair raises or lowers the seat. Occupant's weight disengages the adjustment mechanism, so height won't change while chair is in use.

Pneumatic-height adjustment is available to allow push-button control of seat height from 16"H to 21½"H. To lower, pull lever on right side while seated. To raise, pull lever and lift your weight off the chair.



Variable back stop allows the back to stop at various tilt angles, including upright. Flick switch forward for full range of back angles. To limit back angle, recline to the desired position and flick switch back.

Tip: To lock in upright position, remove weight from back and flick switch back.

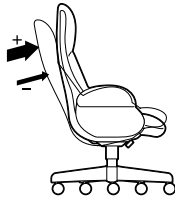

Back tension control varies reclining back support from light to firm and adjusts by turning knob. Turn knob clockwise to decrease tension, counterclockwise to increase.

Tip: Be sure to unlock (release) the variable back stop before adjusting the back tension.

Surface Materials

Upholstery

- Vinyl
- Fabric
- Fabric with soil-retardant treatment (option)
- Leather
- Perforated leather on seat and back (option)

Arms

- Enclosed upholstered arms
- Wood trim on open-arm models only

Column

- Black only

Base

- Black aluminum (standard)
- Wood base caps (option)
- Customiz stain on wood (option)

Casters

- Black only

All Steelcase seating with standard upholstery fabrics complies with requirements of the BIFMA First Generation Voluntary Upholstered Furniture Standard, as well as State of California Technical Bulletins 116 and 117. All standard seating is labeled to be in compliance with California TB116/117.

Programs & Services

► See the *Surface Materials Reference Manual* for further detail about programs and services offered for seating.

The Customer's Own Material (COM) Program

offers the opportunity for customers to select fabrics that are not offered through the standard Steelcase surface materials program for use on Steelcase products. Through the COM program, Steelcase will test your materials for application on Steelcase products. Once approved, you can place your order. Steelcase will facilitate the entire ordering process and give you a production schedule. Steelcase will order the COM fabric directly from the textile manufacturer. For up-to-date information regarding fabric test results for all COM fabrics and details regarding yardage requirements for most Seating lines, visit the COM Web site. To locate the COM Web site:

- Visit www.steelcase.com
- Click on "Knowledge & Design"
- Select "Customer's Own Material"

Soil retardants are treatments that provide long-term soil and stain resistance to a fabric without affecting the shade or the integrity of the fabric. The following Steelcase Textiles are available pre-treated with soil retardant. (You do not need to select the soil-retardant option for these fabrics and incur the \$17 upcharge.)

- Canzoné
- Cavalcade
- Jacks
- Link
- Regis
- Roulette
- Spyder
- Sweepstakes

Soil-retardant treatment is available on all other seating fabrics at an additional \$17 U.S. per seating unit. To order this option, please select "Soil-Retardant Treatment" under "Optional Accessories."

For soil-retardant treatment on COMs, please select "Soil-Retardant Treatment" under "Optional Accessories." Minimums or additional yardage may be required. Please contact the vendor directly for specific information.

Extended lead times may be necessary for this service.

Contact your Steelcase Sales Service representative at 1.888.STEELCASE (1.888.783.3522).

Fire Codes

► See pages 142–145 for upholstery fabrics available for use with FCS modification.

Steelcase offers Fire Code Seating modification (FCS) on nearly all seating models. The most rigorous fire codes in the nation have been developed in California, and the Steelcase FCS modification is designed to meet those codes. Fire Code Seating (FCS) indicates that a product is constructed to meet the strict fire code requirements of high public occupancy areas such as theaters, meeting rooms, and lobbies. The FCS standards will meet both the State of California Home Furnishing Technical Bulletin 133 (Cal TB 133) and Boston Fire Code (BFC). Boston adopted the California Home Furnishing Technical Bulletin TB 133 test standard in 1992.

Fire code approval:

Collegium enclosed-arm models 411 and 421 and all variations of these models are available in the following fabrics only:
Leather
Vinyl

Local codes may have special requirements for upholstery.

Resources

Collegium/Theorem/Decorum Brochure
Form number S11071

Chairs for People at Work

Form number S11347

Collegium Desk Chairs





	Standard Includes	Required to Specify
<ul style="list-style-type: none"> ▶ Need help? Product details, page 22 	<ul style="list-style-type: none"> • Back tension control • Wood trim on open-arm models • Upholstery: fabric price group 1 • Five-arm base: black aluminum • Column: black only • 2"-diameter, hard-composition, dual-wheel casters: black only 	<ol style="list-style-type: none"> 1 Style number 2 Fabric color number for upholstery 3 Wood color number for trim on open-arm models 4 Options, if selected (see below) <ul style="list-style-type: none"> ▶ See <i>Surface Materials</i>, page 136.

	Options	U.S. Price	Required to Specify
Surface Materials	Upholstery		
	• Fabric price group 1	No cost	Specify fabric color number.
	• Fabric price group 2	+\$ 40	Specify fabric color number.
	• Fabric price group 3	+\$132	Specify fabric color number.
	• Fabric price group 4	+\$164	Specify fabric color number.
	• Fabric price group 5	+\$225	Specify fabric color number.
	• Fabric price group 6	+\$288	Specify fabric color number.
	• Fabric price group 7	+\$340	Specify fabric color number.
	• Fabric price group 8	+\$500	Specify fabric color number.
	• Fabric price group 9	+\$640	Specify fabric color number.
• Fabric price group 10	+\$780	Specify fabric color number.	
• Leather price group	+\$835	Specify leather color number.	
• Customer's Own Material (COM) or Customer's Own Leather (COL)	+\$ 55	▶ See <i>Surface Materials Reference Manual</i> .	
• Perforation of leather seat and back	+\$ 65	Add suffix P to the style number and specify leather color number.	
• Fire Code Seating (FCS) on applicable models	+\$ 80	Specify <i>with fire code seating</i> .	
• Soil-retardant treatment applied to upholstery fabric	+\$ 17	▶ Pages 142–145 Specify <i>with soil-retardant treatment</i> .	
	Base		
	• Maple wood base	+\$ 85	Specify <i>with wood base</i> and select wood color number.
	• Customiz stain on wood	+\$ 24	Specify <i>with Customiz stain</i> . ▶ See <i>Surface Materials Reference Manual</i> .
Casters	• 2"-diameter, soft, dual-wheel	+\$ 18	Specify <i>with soft casters</i> .





For Canadian Pricing
Multiply U.S. Price by 1.38.
▶ See page 1 for details.

Specification Information

	Enclosed Upholstered Arms		Open Upholstered Arms with Wood Trim	
				
Description	Style Number	U.S. Base Price	Style Number	U.S. Base Price

High-Back

Manual-height adjustment	411	\$1267	412	\$1372
with variable back stop	411S	\$1327	412S	\$1432
with extended seat	411X	\$1327	412X	\$1432
with variable back stop and extended seat	411SX	\$1387	412SX	\$1492
Pneumatic-height adjustment	411N	\$1327	412N	\$1432
with variable back stop	411NS	\$1387	412NS	\$1492
with extended seat	411NX	\$1387	412NX	\$1492
with variable back stop and extended seat	411NSX	\$1447	412NSX	\$1552

	Enclosed Upholstered Arms		Open Upholstered Arms with Wood Trim	
				
Description	Style Number	U.S. Base Price	Style Number	U.S. Base Price

Mid-Back

Manual-height adjustment	421	\$1162	422	\$1267
with variable back stop	421S	\$1222	422S	\$1327
with extended seat	421X	\$1222	422X	\$1327
with variable back stop and extended seat	421SX	\$1282	422SX	\$1387
Pneumatic-height adjustment	421N	\$1222	422N	\$1327
with variable back stop	421NS	\$1282	422NS	\$1387
with extended seat	421NX	\$1282	422NX	\$1387
with variable back stop and extended seat	421NSX	\$1342	422NSX	\$1447



For Canadian Pricing
 Multiply U.S. Price by 1.38.
 ▶ See page 1 for details.

Decorum

Decorum chairs, designed by Arnie Dammermann, merge European classic camel-back appearance with ergonomic integrity and comfort that is vital in today's workplace.

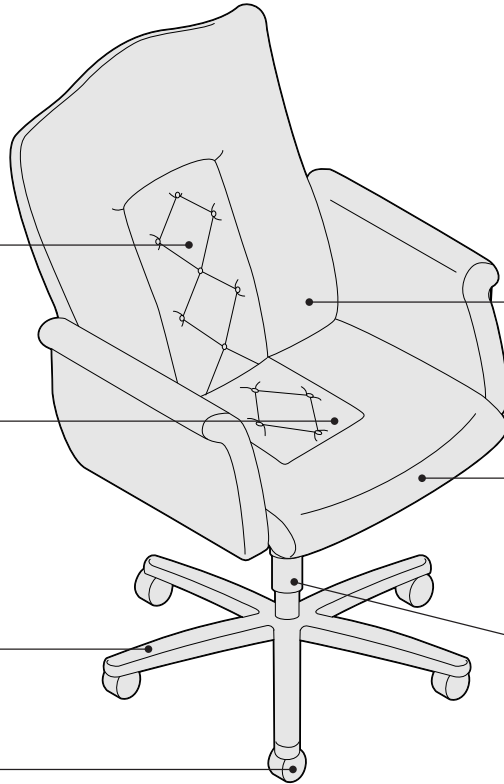

Tufted back insert (optional) accentuates traditional styling.

Seat height adjusts from 16"H to 21½"H and is available with manual or pneumatic adjustment mechanism.

Five-arm base is standard in black aluminum. Solid maple base caps are optional.

Hard dual-wheel casters are provided for use on carpet. Soft dual-wheel casters are available for use on hard floors or chair mats.

Lumbar contours provide lower back support.

Waterfall front edge eases pressure behind user's legs and enhances circulation.

Synchro-tilt mechanism

Product Details

Plain-back insert is standard with high-back, and mid-back.

Tufted insert is available for an alternative traditional look. Add suffix **T** to style number.

Five-arm base is standard, in black aluminum. Solid maple base caps are optional.

Extended depth seat option, at 17½"D, adds 1½" to accommodate longer legs.



Arms are either enclosed upholstered with modified scroll detail, or open upholstered with wood trim.

All Decorum chairs comply with ANSI/HFS and BIFMA standards. *Exception: The extended seat option exceeds ANSI/HFS seat depth restrictions.*

Optional perforated leather seat and back insert adds ventilated comfort.

Actual Dimensions

	High-Back Desk Chairs		Mid-Back Desk Chairs	
	Open arms	Enclosed arms	Open arms	Enclosed arms
Overall depth	25"	25"	25"	25"
Overall width	27½"	27½"	27½"	27½"
Overall height	45"–50½"	45"–50½"	40"–45½"	40"–45½"
Seat depth	16"	16"	16"	16"
Seat width	20⅞"	20⅞"	20⅞"	20⅞"
Back width	20⅞"	20⅞"	20⅞"	20⅞"
Back height	30"	30"	25"	25"
Width between arms	20"	20"	20"	20"
Seat to floor height	16"–21½"	16"–21½"	16"–21½"	16"–21½"
Arm height from floor	24"–29½"	24¼"–29¾"	24"–29½"	24¼"–29½"

Adjustability Features

- Manual height
- Pneumatic height
- Variable back stop
- Back tension control
- Synchro-tilt mechanism

Adjustment Features

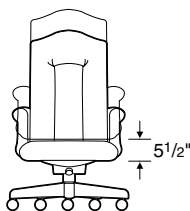

Manual-height adjustment is standard. Rotating the unoccupied chair raises or lowers the seat. Occupant's weight disengages the adjustment mechanism, so height won't change while chair is in use.

Pneumatic-height adjustment is available to allow push-button control from 16"H to 21½"H. To lower, pull lever on right side while seated. To raise, pull lever and lift your weight off the chair.



Variable back stop allows the back to stop at various tilt angles, including fully upright. Flick switch forward for full range of back angles. To limit back angle, recline to the desired and flick switch back.

Tip: To lock in upright position, remove weight from back and flick switch back.

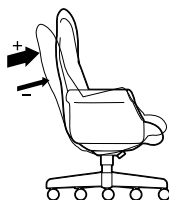

Back tension control varies reclining back support from light to firm and adjusts by turning knob. Turn knob clockwise to decrease tension, counterclockwise to increase.

Tip: Be sure to unlock (release) the variable back stop before adjusting the back tension.

Synchro-tilt mechanism provides synchronized back movement while feet remain flat on the floor.

Surface Materials

Upholstery

- Vinyl
- Fabric
- Fabric with soil-retardant treatment (option)
- Leather
- Perforated leather on seat and back (option)

Arms

- Enclosed upholstered with modified-scroll detail or open upholstered with wood trim

Column

- Black only

Base

- Black aluminum (standard)
- Wood base caps (option)
- Custom stain on wood (option)

All Steelcase seating with standard upholstery fabrics

complies with requirements of the BIFMA First Generation Voluntary Upholstered Furniture Standard, as well as State of California Technical Bulletins 116 and 117. All standard seating is labeled to be in compliance with California TB116/117.

Programs & Services

► See the *Surface Materials Reference Manual* for further detail about programs and services offered for seating.

The Customer's Own Material (COM) Program

offers the opportunity for customers to select fabrics that are not offered through the standard Steelcase surface materials program for use on Steelcase products. Through the COM program, Steelcase will test your materials for application on Steelcase products. Once approved, you can place your order. Steelcase will facilitate the entire ordering process and give you a production schedule. Steelcase will order the COM fabric directly from the textile manufacturer. For up-to-date information regarding fabric test results for all COM fabrics and details regarding yardage requirements for most Seating lines, visit the COM Web site. To locate the COM Web site:

- Visit www.steelcase.com
- Click on "Knowledge & Design"
- Select "Customer's Own Material"

Soil retardants are treatments that provide long-term soil and stain resistance to a fabric without affecting the shade or the integrity of the fabric. The following Steelcase Textiles are available pre-treated with soil retardant. (You do not need to select the soil-retardant option for these fabrics and incur the \$17 upcharge.)

- Canzoné
- Cavalcade
- Jacks
- Link
- Regis
- Roulette
- Spyder
- Sweepstakes

Soil-retardant treatment is available on all other seating fabrics at an additional \$17 U.S. per seating unit. To order this option, please select "Soil-Retardant Treatment" under "Optional Accessories."

For soil-retardant treatment on COMs, please select "Soil-Retardant Treatment" under "Optional Accessories." Minimums or additional yardage may be required. Please contact the vendor directly for specific information.

Extended lead times may be necessary for this service.

Contact your Steelcase Sales Service representative at 1.888.STEELCASE (1.888.783.3522).

Fire Codes

► See pages 142–145 for upholstery fabrics available for use with FCS modification.

Steelcase offers Fire Code Seating modification (FCS) on nearly all seating models. The most rigorous fire codes in the nation have been developed in California, and the Steelcase FCS modification is designed to meet those codes. Fire Code Seating (FCS) indicates that a product is constructed to meet the strict fire code requirements of high public occupancy areas such as theaters, meeting rooms, and lobbies. The FCS standards will meet both the State of California Home Furnishing Technical Bulletin 133 (Cal TB 133) and Boston Fire Code (BFC). Boston adopted the California Home Furnishing Technical Bulletin TB 133 test standard in 1992.

Fire code approval:

Decorum enclosed-arm models 211 and 221 and all variations of these models are available in the following fabrics only:

- Leather
- Vinyl

Local codes may have special requirements for upholstery.

Resources

Collegium/Theorem/Decorum Brochure
Form number S11071

Chairs for People at Work

Form number S11347

Quick Delivery Handbook

Form number S3408

Casegoods and Seating Delivered in 12 Days

Form number S3461

Decorum Desk Chairs



Standard Includes		Required to Specify
<ul style="list-style-type: none"> ▶ Need help? Product details, page 26 	<ul style="list-style-type: none"> • Back tension control • Wood trim on open-arm models • Upholstery: fabric price group 1 • Five-arm base: black aluminum • Column: black only • 2"-diameter, hard-composition, dual-wheel casters: black only 	<ol style="list-style-type: none"> 1 Style number 2 Fabric color number for upholstery 3 Wood color number for trim on open-arm models 4 Options, if selected (see below) <ul style="list-style-type: none"> ▶ See <i>Surface Materials</i>, page 136.

	Options	U.S. Price	Required to Specify
Surface Materials	Upholstery		
	• Fabric price group 1	No cost	Specify fabric color number.
	• Fabric price group 2	+\$ 40	Specify fabric color number.
	• Fabric price group 3	+\$132	Specify fabric color number.
	• Fabric price group 4	+\$164	Specify fabric color number.
	• Fabric price group 5	+\$225	Specify fabric color number.
	• Fabric price group 6	+\$288	Specify fabric color number.
	• Fabric price group 7	+\$340	Specify fabric color number.
	• Fabric price group 8	+\$500	Specify fabric color number.
	• Fabric price group 9	+\$640	Specify fabric color number.
	• Fabric price group 10	+\$780	Specify fabric color number.
	• Leather price group	+\$835	Specify leather color number.
	• Customer's Own Material (COM) or Customer's Own Leather (COL)	+\$ 55	▶ See <i>Surface Materials Reference Manual</i> .
• Perforation of leather seat and back	+\$ 65	Add suffix P to the style number and specify leather color number.	
• Fire Code Seating (FCS) on applicable models	+\$ 80	Specify <i>with fire code seating</i> .	
• Soil-retardant treatment applied to upholstery fabric	+\$ 17	▶ Pages 142–145 Specify <i>with soil-retardant treatment</i> .	
	Base		
	• Maple wood base	+\$ 85	Specify <i>with wood base</i> and select wood color number.
	• Customiz stain on wood	+\$ 24	Specify <i>with Customiz stain</i> . ▶ See <i>Surface Materials Reference Manual</i> .
Back Inserts	• Tufted back insert	+\$ 55	Add suffix T to the style number.
Casters	• 2"-diameter, soft, dual-wheel	+\$ 18	Specify <i>with soft casters</i> .



Tip: Always add suffixes in alphabetical order when specifying options to Decorum desk chairs.

Tip: Add suffix **T** to style number for tufted insert option.





For Canadian Pricing
Multiply U.S. Price by 1.38.
▶ See page 1 for details.

Specification Information

	Enclosed Upholstered Arms		Open Upholstered Arms with Wood Trim	
				
Description	Style Number	U.S. Base Price	Style Number	U.S. Base Price

High-Back

Manual-height adjustment	211	\$1334	212	\$1439
with variable back stop	211S	\$1394	212S	\$1499
with extended seat	211X	\$1394	212X	\$1499
with variable back stop and extended seat	211SX	\$1454	212SX	\$1559
Pneumatic-height adjustment	211N	\$1394	212N	\$1499
with variable back stop	211NS	\$1454	212NS	\$1559
with extended seat	211NX	\$1454	212NX	\$1559
with variable back stop and extended seat	211NSX	\$1514	212NSX	\$1619

	Enclosed Upholstered Arms		Open Upholstered Arms with Wood Trim	
				
Description	Style Number	U.S. Base Price	Style Number	U.S. Base Price

Mid-Back

Manual-height adjustment	221	\$1229	222	\$1334
with variable back stop	221S	\$1289	222S	\$1394
with extended seat	221X	\$1289	222X	\$1394
with variable back stop and extended seat	221SX	\$1349	222SX	\$1454
Pneumatic-height adjustment	221N	\$1289	222N	\$1394
with variable back stop	221NS	\$1349	222NS	\$1454
with extended seat	221NX	\$1349	222NX	\$1454
with variable back stop and extended seat	221NSX	\$1409	222NSX	\$1514



For Canadian Pricing
 Multiply U.S. Price by 1.38.
 ▶ See page 1 for details.

Mansfield

Desk Chairs

Mansfield desk seating is a cost-effective, traditional collection with Chippendale aesthetics. Mansfield desk chairs complement Monarch and Churchill wood case-goods.

Brass tack accenting is optional.

Seat height adjusts from 18½"H to 21½"H. Pneumatic adjustment mechanism is standard.

Five-arm base with maple base caps is standard.

Antique brass-hooded ball casters are standard.

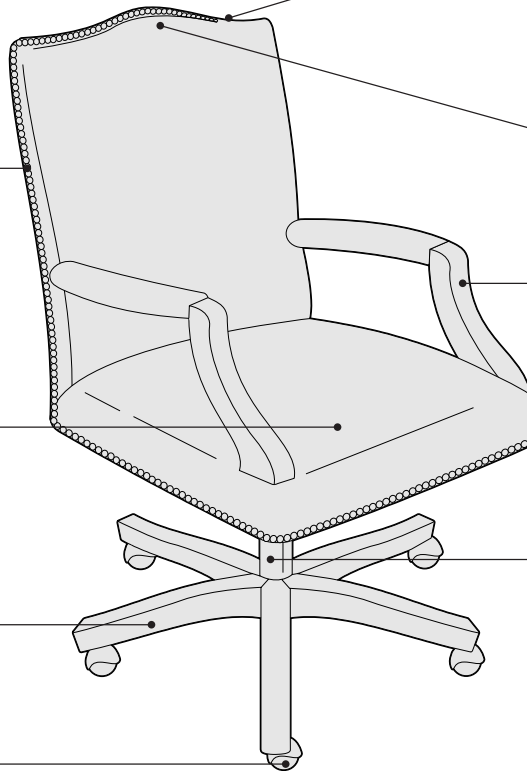

Welting on back is standard.

Camel back enhances traditional styling.

Arms are solid maple with upholstered arm rests.

Knee-tilt/low front rise mechanism with upright back lock is standard.

Product Details



Mid- and high-back desk chairs are available.

Five-arm base provides optimum balance. It is standard with maple base caps that are stained in the selected wood color.

Actual Dimensions

	High-Back Desk Chairs	Mid-Back Desk Chairs
Overall depth	30½"	28½"
Overall width	24½"	24½"
Overall height	43⅞"–46⅜"	38¾"–41¼"
Seat depth	19½"	19½"
Seat width	19"	19"
Back width	21"	21"
Back height from seat	27½"	22½"
Width between arms	19"	19"
Seat to floor height	17⅝"–20⅛"	17⅝"–20⅛"
Arm height from floor	25⅜"–27⅞"	25⅜"–27⅞"

Adjustability Features

- Pneumatic height
- Knee-tilt mechanism
- Upright back lock
- Back tension

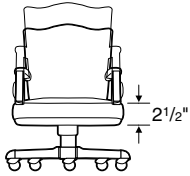
Adjustment Features

Pneumatic-height adjustment, standard on all desk chair models, allows seat height adjustment from 17⁵/₈"H to 20¹/₈"H with fingertip pneumatic lever. To lower, hold handle up while seated. To raise, hold handle up and lift your weight off the chair.

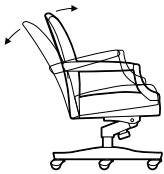

Knee-tilt (low front rise) minimizes the rise of the front of the seat when the chair is in a reclined position, allowing the user's feet to remain on the floor. This feature reduces pressure under the thighs, allowing for continuous blood circulation.

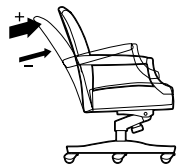

Back tension control varies reclining back support from light to firm and adjusts by turning knob. Turn knob clockwise to decrease tension, counterclockwise to increase.

Tip: Be sure to unlock (release) the variable back stop before adjusting the back tension.

Upright back lock. To lock back upright, push lever down while sitting upright. To release back lock, pull lever up while sitting upright.

Surface Materials**Upholstery**

- Vinyl
- Fabric
- Fabric with soil-retardant treatment (option)
- Leather

Arms

- Wood with upholstered arm caps

Base and column

- Wood base caps and black column

Frame

- Wood
- Tip: Arms and base caps are constructed of solid maple. Finishes applied to maple will match the color of stains applied to oak, walnut, or cherry, but will not show the same natural grain.*
- Custom stain on wood (option)

Casters

- Antique brass only

All Steelcase seating with standard upholstery fabrics

complies with requirements of the BIFMA First Generation Upholstered Furniture Standard, as well as State of California Technical Bulletins 116 and 117. All standard seating is labeled to be in compliance with California TB116/117.

Programs & Services

▶ See the *Surface Materials Reference Manual* for further detail about programs and services offered for seating.

The Customer's Own Material (COM) Program

offers the opportunity for customers to select fabrics that are not offered through the standard Steelcase surface materials program for use on Steelcase products. Through the COM program, Steelcase will test your materials for application on Steelcase products. Once approved, you can place your order. Steelcase will facilitate the entire ordering process and give you a production schedule. Steelcase will order the COM fabric directly from the textile manufacturer. For up-to-date information regarding fabric test results for all COM fabrics and details regarding yardage requirements for most Seating lines, visit the COM Web site. To locate the COM Web site:

- Visit www.steelcase.com
- Click on "Knowledge & Design"
- Select "Customer's Own Material"

Soil retardants are treatments that provide long-term soil and stain resistance to a fabric without affecting the shade or the integrity of the fabric. The following Steelcase Textiles are available pre-treated with soil retardant. (You do not need to select the soil-retardant option for these fabrics and incur the \$17 upcharge.)

- Canzoné
- Cavalcade
- Jacks
- Link
- Regis
- Roulette
- Spyder
- Sweepstakes

Soil-retardant treatment is available on all other seating fabrics at an additional \$17 U.S. per seating unit. To order this option, please select "Soil-Retardant Treatment" under "Optional Accessories."

For soil-retardant treatment on COMs, please select "Soil-Retardant Treatment" under "Optional Accessories." Minimums or additional yardage may be required. Please contact the vendor directly for specific information.

Extended lead times may be necessary for this service.

Contact your Steelcase Sales Service representative at 1.888.STEELCASE (1.888.783.3522).

Fire Codes

▶ See pages 142–145 for upholstery fabrics available for use with FCS modification.

Steelcase offers Fire Code Seating modification (FCS) on nearly all seating models. The most rigorous fire codes in the nation have been developed in California, and the Steelcase FCS modification is designed to meet those codes. Fire Code Seating (FCS) indicates that a product is constructed to meet the strict fire code requirements of high public occupancy areas such as theaters, meeting rooms, and lobbies. The FCS standards will meet both the State of California Home Furnishing Technical Bulletin 133 (Cal TB 133) and Boston Fire Code (BFC). Boston adopted the California Home Furnishing Technical Bulletin TB 133 test standard in 1992.

Fire code approval:

Mansfield high-back model 140 and all variations of this model are available in the following fabrics only:
Leather
Vinyl

Local codes may have special requirements for upholstery.

Resources**Traditional Brochure**

Form number S11196

Chairs for People at Work

Form number S11347

Quick Delivery Handbook

Form number S3408

Casegoods and Seating Delivered in 12 Days

Form number S3461

Mansfield Desk Chairs



Standard Includes		Required to Specify
<ul style="list-style-type: none"> ▶ Need help? Product details, page 30 	<ul style="list-style-type: none"> • Back tension control • Knee-tilt mechanism • Upright back lock • Upholstery: fabric price group 1 • Five-arm base: maple base caps • Column: black only • Antique brass-hooded hard-composition ball casters 	<ol style="list-style-type: none"> 1 Style number 2 Wood color number for base caps and arms 3 Fabric color number for upholstery 4 Options, if selected (see below) <ul style="list-style-type: none"> ▶ See <i>Surface Materials</i>, page 136.

Options	U.S. Price	Required to Specify
Surface Materials	Upholstery	
<ul style="list-style-type: none"> • Fabric price group 1 • Fabric price group 2 • Fabric price group 3 • Fabric price group 4 • Fabric price group 5 • Fabric price group 6 • Fabric price group 7 • Fabric price group 8 • Fabric price group 9 • Fabric price group 10 • Leather price group • Customer's Own Material (COM) or Customer's Own Leather (COL) • Fire Code Seating (FCS) on applicable models • Soil-retardant treatment applied to upholstery fabric 	<ul style="list-style-type: none"> No cost +\$ 30 +\$ 99 +\$123 +\$170 +\$216 +\$255 +\$375 +\$480 +\$585 +\$835 +\$ 45 	<ul style="list-style-type: none"> Specify fabric color number. Specify fabric color number. Specify fabric color number. Specify fabric color number. Specify fabric color number. Specify fabric color number. Specify fabric color number. Specify fabric color number. Specify fabric color number. Specify fabric color number. Specify leather color number. <ul style="list-style-type: none"> ▶ See <i>Surface Materials Reference Manual</i>.
Brass tacks	+\$ 35	Add suffix B to the style number.
Frame		
<ul style="list-style-type: none"> • Customiz stain on wood 	+\$ 24	<ul style="list-style-type: none"> Specify with <i>Customiz stain</i>. ▶ See <i>Surface Materials Reference Manual</i>.

Specification Information

High-Back Desk Chair



Mid-Back Desk Chair



Description	Style Number	U.S. Base Price	Style Number	U.S. Base Price
Pneumatic-height adjustment	140	\$898	141	\$798



For Canadian Pricing
 Multiply U.S. Price by 1.38.
 ▶ See page 1 for details.



For Canadian Pricing
Multiply U.S. Price by 1.38.
▶ See page 1 for details.

Masque

Contemporary executive open arm desk chair. Thin, angular profile upholstered in leather and vinyl.

Fully upholstered outer back is standard.

Seat is generously proportioned in both depth and width. Seat height adjusts from 16"H to 19"H with standard pneumatic adjustment mechanism.

Five-arm base is metal with a black plastic overlay.

Hard dual-wheel casters are provided for use on carpet. Soft dual-wheel casters are available for use on hard floors or chair mats.



Inside surfaces are upholstered in leather. Outside back is upholstered in matching vinyl.

Lumbar contours provide lower back support.

Open arms are plastic with leather upholstered arm caps.

Waterfall front edge eases pressure on the backs of the user's legs and enhances circulation.

Product Details

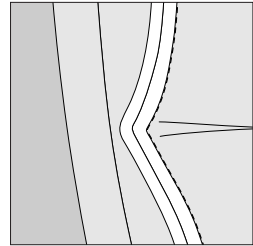

High-back executive desk chairs are accented with stitching detail.

Five-arm base provides optimum balance.



Knee-tilt (low front rise) minimizes the rise of the front of the seat when the chair is in a reclined position, allowing the user's feet to remain on the floor. This feature reduces pressure under the thighs, allowing for continuous blood circulation.

Actual Dimensions

Overall depth	28"
Overall width	25 ³ / ₄ "
Overall height	42"-45"
Seat depth	19 ¹ / ₂ "
Seat width	20 ³ / ₄ "
Back width	20 ³ / ₄ "
Back height	26 ⁵ / ₈ "
Width between arms	20"
Seat to floor height	16"-19"
Arm height from floor	26"-29"

Adjustability Features

- Pneumatic height
- Upright back lock
- Back tension
- Knee-tilt control

Adjustment Features

Seat height adjusts pneumatically.

To lower, hold handle up while seated. To raise, hold handle up and keep your weight off the chair.

Upright back lock. Push the pneumatic height control lever into lock, pull the lever out to tilt.

Back tension control adjusts by turning a knob. Turn knob clockwise to increase tension and counterclockwise to decrease tension.

Surface Materials

Upholstery

- Black leather and vinyl
- Burgundy leather and vinyl

Tip: All inside surfaces are upholstered in leather and outside surfaces are upholstered in matching vinyl.

Samples of the leather are not available. However, they are similar in color to Steelcase L107 Black and L507 Vineyard leather.

Arms

- Black open arms with upholstered arm caps

Base and column

- Black base and column

Casters

- Black only

All Steelcase seating with standard upholstery fabrics complies with requirements of the BIFMA First Generation Voluntary Upholstered Furniture Flammability Standard, as well as the State of California Technical Bulletins 116 and 117. All standard seating is labeled to be in compliance with California TB116/117.

Programs & Services

Soil retardant treatment is not available.

Fire Code Seating (FCS) modification is not available.

Local codes may have special requirements for upholstery.

Resources

Masque Brochure
Form number S11093

Chairs for People at Work
Form number S11347

Quick Delivery Handbook
Form number S3408

Casegoods and Seating Delivered in 12 Days
Form number S3461

Masque Desk Chairs



	Standard Includes	Required to Specify
<p>▶ Need help? Product details, page 34</p>	<ul style="list-style-type: none"> • Back tension control • Knee-tilt control • Upright back lock • Open arms: upholstered arm caps and black plastic underarm structure • Upholstery on inside back, seat, and arm caps: leather • Upholstery on outside back: vinyl • Five-arm base and column: black only • 2"-diameter, hard-composition, dual-wheel casters: black only 	<p>1 Style number 2 Options, if selected (see below)</p>

	Options	U.S. Price	Required to Specify
Casters	<ul style="list-style-type: none"> • Soft, dual-wheel casters on desk chairs for use on hard floors (2¹/₂" 	+\$18	Specify <i>with soft casters</i> .

Specification Information

Description	Style Number	U.S. Base Price

High-Back Desk Chair with Black Leather

Pneumatic-height adjustment	300	\$1257

High-Back Desk Chair with Burgundy Leather

Pneumatic-height adjustment	305	\$1257



For Canadian Pricing
Multiply U.S. Price by 1.38.
▶ See page 1 for details.



For Canadian Pricing
Multiply U.S. Price by 1.38.
▶ See page 1 for details.

Theorem

Theorem desk chairs, a Lisa Smith design, have a neutral, rectilinear design that is appropriate in contemporary or transitional settings. This chair line offers numerous ergonomic support features.

Double stitching accents the back and seat.

Seat height adjusts from 16"H to 21½"H and is available with manual or pneumatic adjustment mechanism.

Five-arm base is standard in black aluminum. Solid maple base caps are optional.

Hard dual-wheel casters are provided for use on carpet. Soft dual-wheel casters are available for use on hard floors or chair mats.

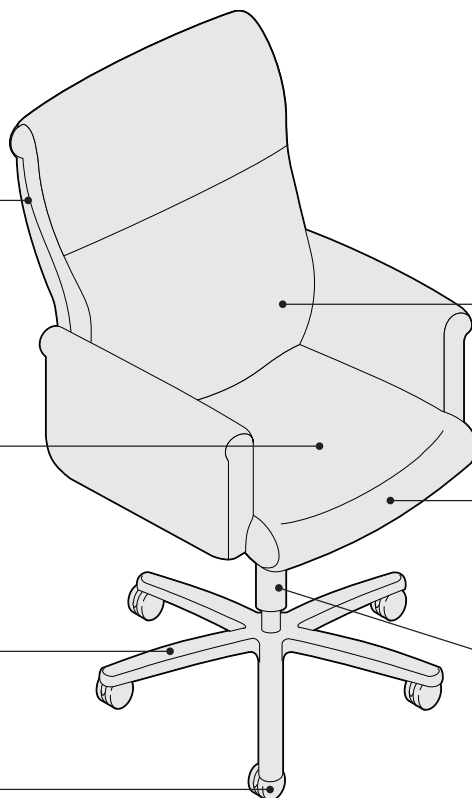

Lumbar contours provide lower back support.

Waterfall front edge eases pressure under user's legs and enhances circulation.

Synchro-tilt mechanism

Product Details

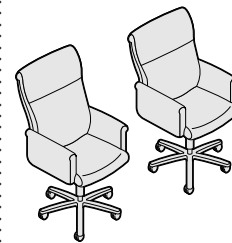

High- and mid-back desk chairs are available.



Enclosed arms are upholstered.

Extended-depth seat option, at 17½", adds 1½" to accommodate longer legs.

All Theorem desk chairs comply with ANSI/HFS and BIFMA standards.

Exception: The extended seat option exceeds ANSI/HFS seat depth restrictions.

Optional perforated leather seat and back adds ventilated comfort.

Actual Dimensions

	High-Back Desk Chairs	Mid-Back Desk Chairs
Overall depth	25"	25"
Overall width	27"	27"
Overall height	45"–50½"	40"–45½"
Seat depth	16"	16"
Seat width	20½"	20½"
Back width	20½"	20½"
Back height	30"	25"
Width between arms	20½"	20½"
Seat to floor height	16"–21½"	16"–21½"
Arm height from floor	24¾"–30¼"	24¾"–30¼"

Adjustability Features

- Manual height
- Pneumatic height
- Variable back stop
- Back tension control
- Synchro-tilt mechanism

Adjustment Features

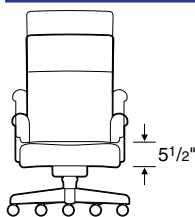

Manual-height adjustment is standard. Rotating the unoccupied chair raises or lowers the seat. Occupant's weight disengages the adjustment mechanism, so height won't change while chair is in use.

Pneumatic-height adjustment is available to allow push-button control from 16"H to 21½"H. To lower, pull lever on right side while seated. To raise, pull lever and lift your weight off the chair.

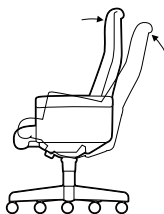

Variable back stop allows the back to stop at various tilt angles, including fully upright. Flick switch forward for full range of back angles. To limit back angle, recline to the desired position and flick switch back.
Tip: To lock in upright position, remove weight from back and flick switch back.

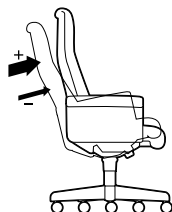

Back tension control varies reclining back support from light to firm and adjusts by turning knob. Turn knob clockwise to decrease tension, counterclockwise to increase.

Tip: Be sure to unlock (release) the variable back stop before adjusting the back tension.

Synchro-tilt mechanism provides synchronized back movement while feet remain flat on floor.

Surface Materials

Upholstery

- Vinyl
- Fabric
- Fabric with soil-retardant treatment (option)
- Leather
- Perforated leather on seat and back (option)

Arms

- Enclosed upholstered arms

Column

- Black only

Base

- Black aluminum (standard)
- Polished aluminum (option)
- Wood base caps (option)
- Custom stain on wood (option)

Casters

- Black only

All Steelcase seating with standard upholstery fabrics complies with requirements of the BIFMA First Generation Voluntary Upholstered Furniture Standard, as well as State of California Technical Bulletins 116 and 117. All standard seating is labeled to be in compliance with California TB116/117.

Programs & Services

► See the *Surface Materials Reference Manual* for further detail about programs and services offered for seating.

The Customer's Own Material (COM) Program

offers the opportunity for customers to select fabrics that are not offered through the standard Steelcase surface materials program for use on Steelcase products. Through the COM program, Steelcase will test your materials for application on Steelcase products. Once approved, you can place your order. Steelcase will facilitate the entire ordering process and give you a production schedule. Steelcase will order the COM fabric directly from the textile manufacturer. For up-to-date information regarding fabric test results for all COM fabrics and details regarding yardage requirements for most Seating lines, visit the COM Web site. To locate the COM Web site:

- Visit www.steelcase.com
- Click on "Knowledge & Design"
- Select "Customer's Own Material"

Soil retardants are treatments that provide long-term soil and stain resistance to a fabric without affecting the shade or the integrity of the fabric. The following Steelcase Textiles are available pre-treated with soil retardant. (You do not need to select the soil-retardant option for these fabrics and incur the \$17 upcharge.)

- Canzoné
- Cavalcade
- Jacks
- Link
- Regis
- Roulette
- Spyder
- Sweepstakes

Soil-retardant treatment is available on all other seating fabrics at an additional \$17 U.S. per seating unit. To order this option, please select "Soil-Retardant Treatment" under "Optional Accessories."

For soil-retardant treatment on COMs, please select "Soil-Retardant Treatment" under "Optional Accessories." Minimums or additional yardage may be required. Please contact the vendor directly for specific information.

Extended lead times may be necessary for this service.

Contact your Steelcase Sales Service representative at 1.888.STEELCASE (1.888.783.3522).

Fire Codes

► See pages 142–145 for upholstery fabrics available for use with FCS modification.

Steelcase offers Fire Code Seating modification (FCS) on nearly all seating models. The most rigorous fire codes in the nation have been developed in California, and the Steelcase FCS modification is designed to meet those codes. Fire Code Seating (FCS) indicates that a product is constructed to meet the strict fire code requirements of high public occupancy areas such as theaters, meeting rooms, and lobbies. The FCS standards will meet both the State of California Home Furnishing Technical Bulletin 133 (Cal TB 133) and Boston Fire Code (BFC). Boston adopted the California Home Furnishing Technical Bulletin TB 133 test standard in 1992.

Local codes may have special requirements for upholstery.

Resources

Collegium/Theorem/Decorum Brochure
Form number S11071

Chairs for People at Work

Form number S11347

Quick Delivery Handbook
Form number S3408

Casegoods and Seating Delivered in 12 Days
Form number S3461

Theorem Desk Chairs



Standard Includes		Required to Specify	
<ul style="list-style-type: none"> ▶ Need help? Product details, page 38 	<ul style="list-style-type: none"> • Back tension control • Upholstery: fabric price group 1 • Five-arm base: black aluminum • Column: black only • 2"-diameter, hard-composition, dual-wheel casters: black only 	<ol style="list-style-type: none"> 1 Style number 2 Fabric color number for upholstery 3 Options, if selected (see below) <ul style="list-style-type: none"> ▶ See <i>Surface Materials</i>, page 136. 	

Options	U.S. Price	Required to Specify	
Surface Materials			
Upholstery <ul style="list-style-type: none"> • Fabric price group 1 • Fabric price group 2 • Fabric price group 3 • Fabric price group 4 • Fabric price group 5 • Fabric price group 6 • Fabric price group 7 • Fabric price group 8 • Fabric price group 9 • Fabric price group 10 • Leather price group • Customer's Own Material (COM) or Customer's Own Leather (COL) • Perforation of leather seat and back • Fire Code Seating (FCS) on applicable models • Soil-retardant treatment applied to upholstery fabric 	<ul style="list-style-type: none"> No cost +\$ 40 +\$132 +\$164 +\$225 +\$288 +\$340 +\$500 +\$640 +\$780 +\$835 +\$ 55 +\$ 65 +\$ 80 +\$ 17 	<ul style="list-style-type: none"> Specify fabric color number. Specify fabric color number. Specify fabric color number. Specify fabric color number. Specify fabric color number. Specify fabric color number. Specify fabric color number. Specify fabric color number. Specify fabric color number. Specify fabric color number. Specify leather color number. ▶ See <i>Surface Materials Reference Manual</i>. 	<ul style="list-style-type: none"> Add suffix P to the style number and specify leather color number. Specify <i>with fire code seating</i>. ▶ Pages 142–145 Specify <i>with soil-retardant treatment</i>.
Base <ul style="list-style-type: none"> • Maple wood base • Customiz stain on wood base 	<ul style="list-style-type: none"> +\$ 85 +\$ 24 	<ul style="list-style-type: none"> Specify <i>with wood base</i> and select wood color number. Specify <i>with Customiz stain</i>. ▶ See <i>Surface Materials Reference Manual</i>. 	
Casters <ul style="list-style-type: none"> • 2"-diameter, soft, dual-wheel 	<ul style="list-style-type: none"> +\$ 18 	<ul style="list-style-type: none"> Specify <i>with soft casters</i>. 	



For Canadian Pricing
 Multiply U.S. Price by 1.38.
 ▶ See page 1 for details.

Specification Information

Enclosed Upholstered Arms



Description	Style Number	U.S. Base Price
-------------	--------------	-----------------

High-Back

Manual-height adjustment	711	\$1225
with variable back stop	711S	\$1285
with extended seat	711X	\$1285
with variable back stop and extended seat	711SX	\$1345
Pneumatic-height adjustment	711N	\$1285
with variable back stop	711NS	\$1345
with extended seat	711NX	\$1345
with variable back stop and extended seat	711NSX	\$1405

Enclosed Upholstered Arms



Description	Style Number	U.S. Base Price
-------------	--------------	-----------------

Mid-Back

Manual-height adjustment	721	\$1122
with variable back stop	721S	\$1182
with extended seat	721X	\$1182
with variable back stop and extended seat	721SX	\$1242
Pneumatic-height adjustment	721N	\$1182
with variable back stop	721NS	\$1242
with extended seat	721NX	\$1242
with variable back stop and extended seat	721NSX	\$1302



For Canadian Pricing
 Multiply U.S. Price by 1.38.
 ▶ See page 1 for details.



General-Use Seating

Ascot	44
Gentry	48

Ascot

Ascot—contemporary desk seating with softly contoured curvilinear lines. Scaled for office environments where space is at a premium.

Fully upholstered outer back is standard.

Seat height adjusts from 16"H to 21"H and is available with a manual or pneumatic adjustment mechanism.

Five-arm base is standard. Wood base caps are available.

Hard dual-wheel casters are provided for use on carpet. Soft dual-wheel casters are available for use on hard floors or chair mats.



Backrest curves to provide proper support and prevent fatigue and strain.

Product Details



Low- and high-back desk chairs are available.

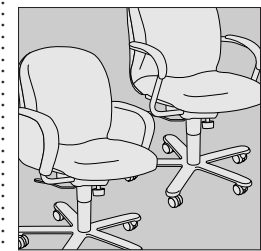

Arms on desk chairs can be enclosed or open.

Enclosed arms are fully upholstered to match the seat and back.

Open-arms are black metal and have upholstered arm caps that match the seat and back.

Five-arm base provides optimum balance. It is available with a maple wood base cap that is stained in the selected wood color.

Advanced swivel-tilt feature incorporates a no front-rise design that allows the seat to remain level even when the user leans back.

Actual Dimensions

	High-Back Desk Chairs		Low-Back Desk Chairs	
	Open Arms	Enclosed Arms	Open Arms	Enclosed Arms
Overall depth	23½"	23½"	23½"	23½"
Overall width	21"	23½"	21"	23½"
Overall height	36½"–41½"	36½"–41½"	34"–39"	34"–39"
Seat depth	16"	16"	16"	16"
Seat width	19"	18¾"	19"	18¾"
Back width	19"	18¾"	19"	18¾"
Back height	21"	21"	19"	19"
Width between arms	19"	18¾"	19"	18¾"
Seat to floor height	16"–21"	16"–21"	16"–21"	16"–21"
Arm height from floor	22½"–27½"	24"–29"	22½"–27½"	24"–29"

Adjustability Features

- Manual height
- Pneumatic height
- Upright back lock
- Back tension

Adjustment Features

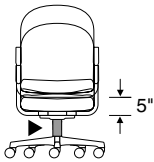

Seat height adjusts manually by spinning the seat clockwise to lower it and counterclockwise to raise it while keeping the base stationary.

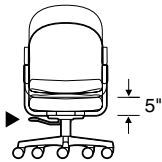

Seat height adjusts pneumatically. To lower, hold handle up while seated. To raise, hold handle up and keep your weight off the chair.



Upright back lock. Flick switch forward to lock, flick switch back to tilt.



Back tension control adjusts by turning a knob. Turn knob clockwise to increase tension and counterclockwise to decrease tension.

Surface Materials

Upholstery

- Vinyl
- Fabric
- Fabric with soil-retardant treatment (option)
- Leather

Arms

- Black open arms with upholstered arm caps
- Upholstered enclosed arms

Base and column

- Black base and column (standard)
- Wood base caps and black column (option)

Casters

- Black only

All Steelcase seating with standard upholstery fabrics complies with requirements of the BIFMA First Generation Upholstered Furniture Flammability Standard, as well as the State of California Technical Bulletins 116 and 117. All standard seating is labeled to be in compliance with California TB116/117.

Programs & Services

▶ See the *Surface Materials Reference Manual* for further detail about programs and services offered for seating.

The Customer's Own Material (COM) Program

offers the opportunity for customers to select fabrics that are not offered through the standard Steelcase surface materials program for use on Steelcase products. Through the COM program, Steelcase will test your materials for application on Steelcase products. Once approved, you can place your order. Steelcase will facilitate the entire ordering process and give you a production schedule. Steelcase will order the COM fabric directly from the textile manufacturer. For up-to-date information regarding fabric test results for all COM fabrics and details regarding yardage requirements for most Seating lines, visit the COM Web site. To locate the COM Web site:

- Visit www.steelcase.com
- Click on "Knowledge & Design"
- Select "Customer's Own Material"

Soil retardants are treatments that provide long-term soil and stain resistance to a fabric without affecting the shade or the integrity of the fabric. The following Steelcase Textiles are available pre-treated with soil retardant. (You do not need to select the soil-retardant option for these fabrics and incur the \$17 upcharge.)

- Canzoné
- Cavalcade
- Jacks
- Link
- Regis
- Roulette
- Spyder
- Sweepstakes

Soil-retardant treatment is available on all other seating fabrics at an additional \$17 U.S. per seating unit. To order this option, please select "Soil-Retardant Treatment" under "Optional Accessories."

For soil-retardant treatment on COMs, please select "Soil-Retardant Treatment" under "Optional Accessories." Minimums or additional yardage may be required. Please contact the vendor directly for specific information.

Extended lead times may be necessary for this service.

Contact your Steelcase Sales Service representative at 1.888.STEELCASE (1.888.783.3522).

Fire Codes

▶ See pages 142–145 for upholstery fabrics available for use with FCS modification.

Steelcase offers Fire Code Seating modification (FCS) on nearly all seating models. The most rigorous fire codes in the nation have been developed in California, and the Steelcase FCS modification is designed to meet those codes. Fire Code Seating (FCS) indicates that a product is constructed to meet the strict fire code requirements of high public occupancy areas such as theaters, meeting rooms, and lobbies. The FCS standards will meet both the State of California Home Furnishing Technical Bulletin 133 (Cal TB 133) and Boston Fire Code (BFC). Boston adopted the California Home Furnishing Technical Bulletin TB 133 test standard in 1992.

Fire code approval:

Ascot enclosed-arm models 296 and 276 and all variations of these models are available in the following fabrics only:
Leather
Vinyl

Local codes may have special requirements for upholstery.

Resources

Ascot Brochure
Form number S2773

Quick Delivery Handbook
Form number S3408

Casegoods and Seating Delivered in 12 Days
Form number S3461

Ascot Desk Chairs





	Standard Includes	Required to Specify
<p>► Need help? Product details, page 44</p>	<ul style="list-style-type: none"> • Back tension control • Swivel-tilt mechanism • Open arms, if selected: upholstered arm caps and black metal arm support • Enclosed arms, if selected: upholstered • Upholstery: fabric price group 1 • Five-arm base and column on desk chairs: black only • 2½"-diameter, hard-composition, dual-wheel casters on desk chairs: black only 	<ol style="list-style-type: none"> 1 Style number 2 Fabric color number for upholstery 3 Options, if selected (see below) <p>► See <i>Surface Materials</i>, page 136.</p>

	Options	U.S. Price	Required to Specify
Surface Materials	Upholstery		
	• Fabric price group 1	No cost	Specify fabric color number.
	• Fabric price group 2	+\$ 30	Specify fabric color number.
	• Fabric price group 3	+\$ 99	Specify fabric color number.
	• Fabric price group 4	+\$123	Specify fabric color number.
	• Fabric price group 5	+\$170	Specify fabric color number.
	• Fabric price group 6	+\$216	Specify fabric color number.
	• Fabric price group 7	+\$255	Specify fabric color number.
	• Fabric price group 8	+\$375	Specify fabric color number.
	• Fabric price group 9	+\$480	Specify fabric color number.
• Fabric price group 10	+\$585	Specify fabric color number.	
• Leather price group	+\$565	Specify leather color number.	
• Customer's Own Material (COM) or Customer's Own Leather (COL)	+\$ 45	► See <i>Surface Materials Reference Manual</i> .	
• Fire Code Seating (FCS) on applicable models	+\$ 80	Specify <i>with fire code seating</i> .	
• Soil-retardant treatment applied to upholstery fabric	+\$ 17	► Pages 142–145 Specify <i>with soil-retardant treatment</i> .	
	Wood		
	• Wood base	+\$ 85	Specify <i>with wood base</i> and select wood color number.
	• Customiz stain on wood base	+\$ 24	Specify <i>with Customiz stain</i> . ► See <i>Surface Materials Reference Manual</i> .
Casters	• Soft, dual-wheel casters on desk chairs for use on hard floors (2½")	+\$ 18	Specify <i>with soft casters</i> .





For Canadian Pricing
Multiply U.S. Price by 1.38.
► See page 1 for details.

Specification Information

	Open Arms with Upholstered Arm Caps		Enclosed Upholstered Arms	
				
Description	Style Number	U.S. Base Price	Style Number	U.S. Base Price

High-Back

Manual-height adjustment	295	\$782	296	\$851
with upright back lock	295L	\$842	296L	\$911
Pneumatic-height adjustment	295N	\$842	296N	\$911
with upright back lock	295LN	\$902	296LN	\$971

	Open Arms with Upholstered Arm Caps		Enclosed Upholstered Arms	
				
Description	Style Number	U.S. Base Price	Style Number	U.S. Base Price

Low-Back

Manual-height adjustment	275	\$719	276	\$788
with upright back lock	275L	\$779	276L	\$848
Pneumatic-height adjustment	275N	\$779	276N	\$848
with upright back lock	275LN	\$839	276LN	\$908

General-Use



For Canadian Pricing
 Multiply U.S. Price by 1.38.
 ▶ See page 1 for details.

Gentry

Desk Chairs

Gentry chairs, designed by Arnie Dammermann, provide contemporary styling with a distinctive design that features clean, simple lines and natural contours.

▶ See Gentry guest chair, page 70.



Back provides solid ergonomic support.

Seat height adjusts from 16"H to 20½"H and is available with manual or pneumatic adjustment mechanism.

Waterfall seat edge relieves pressure behind user's legs and enhances circulation.

Optional knee-tilt mechanism with forward-tilt seat angle.

Five-arm base is black metal with black plastic base caps or maple base caps.

Hard dual-wheel casters are provided for use on carpet. Soft dual-wheel casters are available for use on hard floors or chair mats.

Product Details

Wood and thermoplastic models are available with high and low backs.

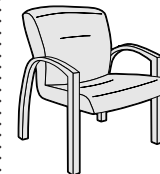

Guest chair is available with a maple frame only.
▶ Page 70

Arms on wood desk models are either enclosed upholstered or open maple with upholstered arm caps.

Arms on thermoplastic models are open and are black plastic colored.

Perforated leather is available on the seat and back to facilitate the flow of air.

Actual Dimensions

	High-Back Desk Chairs		Low-Back Desk Chairs	
	Open arms	Enclosed arms	Open arms	Enclosed arms
Overall depth	26"	26"	26"	26"
Overall width	25"	25"	25"	25"
Overall height	38¼"–42¾"	38¼"–42¾"	33¼"–37¾"	33¼"–37¾"
Seat depth	16½"	16½"	16½"	16½"
Seat width	20½"	20½"	20½"	20½"
Back width	21"	21"	21"	21"
Back height	24"	24"	19"	19"
Width between arms	20"	20"	20"	20"
Seat to floor height	16"–20½"	16"–20½"	16"–20½"	16"–20½"
Arm height from floor	22½"–27"	22½"–27"	22½"–27"	22½"–27"

Adjustability Features

- Manual or pneumatic height
- Swivel-tilt control
- Knee-tilt control (optional)
- Upright back lock (on knee-tilt models only)
- Seat angle adjustment (on knee-tilt models only)
- Back tension control

Adjustment Features

Manual-height adjustment is standard on swivel-tilt base models. Rotating the unoccupied chair raises or lowers the seat. Occupant's weight disengages the adjustment mechanism, so height won't change while chair is in use.

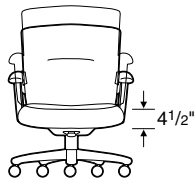

Pneumatic-height adjustment, available on swivel-tilt base models, allows seat height adjustment from 16"H to 20½"H with fingertip pneumatic lever. To lower, hold handle up while seated. To raise, hold handle up and lift your weight off the chair.

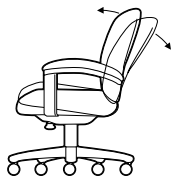

Knee-tilt (low front rise) minimizes the rise of the front of the seat when the chair is in a reclined position, allowing the user's feet to remain on the floor. This feature reduces pressure under the thighs, allowing for continuous blood circulation.

Tip: Pneumatic-height adjustment is standard on knee-tilt models.

Seat angle control adjusts by shifting your weight to the back of the chair and flipping switch upward to engage. Disengage by shifting weight to the back of the chair and flipping switch downward.

Back tension varies reclining back support from light to firm and adjusts by turning knob. Turn knob clockwise to decrease tension, counterclockwise to increase.

Tip: Be sure to unlock (release) the variable back stop before adjusting the back tension.

Upright back lock. To lock back upright, push lever down while sitting upright. To release back lock, pull lever up while sitting upright.

Surface Materials

Seat and back

- Vinyl
- Fabric
- Fabric with soil-retardant treatment (option)
- Leather
- Perforated leather on seat and back (option)

Arms

- Enclosed upholstered arms
- Open wood arms with upholstered arm caps
- Open black plastic arms

Column

- Black metal only

Base

- Wood models have black metal base with solid maple base caps
- Thermoplastic models have black metal base with black plastic base caps
- Customiz stain on wood (option)

Casters

- Black only

All Steelcase seating with standard upholstery fabrics

complies with requirements of the BIFMA First Generation Voluntary Upholstered Furniture Standard, as well as State of California Technical Bulletins 116 and 117. All standard seating is labeled to be in compliance with California TB116/117.

Programs & Services

► See the *Surface Materials Reference Manual* for further detail about programs and services offered for seating.

The Customer's Own Material (COM) Program

offers the opportunity for customers to select fabrics that are not offered through the standard Steelcase surface materials program for use on Steelcase products. Through the COM program, Steelcase will test your materials for application on Steelcase products. Once approved, you can place your order. Steelcase will facilitate the entire ordering process and give you a production schedule. Steelcase will order the COM fabric directly from the textile manufacturer. For up-to-date information regarding fabric test results for all COM fabrics and details regarding yardage requirements for most Seating lines, visit the COM Web site. To locate the COM Web site:

- Visit www.steelcase.com
- Click on "Knowledge & Design"
- Select "Customer's Own Material"

Soil retardants are treatments that provide long-term soil and stain resistance to a fabric without affecting the shade or the integrity of the fabric. The following Steelcase Textiles are available pre-treated with soil retardant. (You do not need to select the soil-retardant option for these fabrics and incur the \$17 upcharge.)

- Canzoné
- Cavalcade
- Jacks
- Link
- Regis
- Roulette
- Spyder
- Sweepstakes

Soil-retardant treatment is available on all other seating fabrics at an additional \$17 U.S. per seating unit. To order this option, please select "Soil-Retardant Treatment" under "Optional Accessories."

For soil-retardant treatment on COMs, please select "Soil-Retardant Treatment" under "Optional Accessories." Minimums or additional yardage may be required. Please contact the vendor directly for specific information.

Extended lead times may be necessary for this service.

Contact your Steelcase Sales Service representative at 1.888.STEELCASE (1.888.783.3522).

Fire Codes

► See pages 142–145 for upholstery fabrics available for use with FCS modification.

Steelcase offers Fire Code Seating modification (FCS) on nearly all seating models. The most rigorous fire codes in the nation have been developed in California, and the Steelcase FCS modification is designed to meet those codes. Fire Code Seating (FCS) indicates that a product is constructed to meet the strict fire code requirements of high public occupancy areas such as theaters, meeting rooms, and lobbies. The FCS standards will meet both the State of California Home Furnishing Technical Bulletin 133 (Cal TB 133) and Boston Fire Code (BFC). Boston adopted the California Home Furnishing Technical Bulletin TB 133 test standard in 1992.

Fire code approval:

Gentry enclosed-arm models 0644W, 0634W, 0644B, 0634B, and all variations of these models are available in the following fabrics only: Leather
Vinyl

Local codes may have special requirements for upholstery.

Resources

Gentry Brochure
Form number S11076

Chairs for People at Work
Form number S11347

Quick Delivery Handbook
Form number S3408

Casegoods and Seating Delivered in 12 Days
Form number S3461

Gentry Desk Chairs

Wood Models



	Standard Includes	Required to Specify
▶ Need help? Product details, page 48	<ul style="list-style-type: none"> • Back tension control • Swivel-tilt control • Upholstery: fabric price group 1 • Five-arm base: black metal with maple base caps • Column: black only • 2"-diameter, hard-composition, dual-wheel casters: black only 	<ol style="list-style-type: none"> 1 Style number 2 Fabric color number for upholstery 3 Wood color number for base and arms, if applicable 4 Options, if selected (see below) <p>▶ See <i>Surface Materials</i>, page 136.</p>

	Options	U.S. Price	Required to Specify
Surface Materials	Upholstery		
	• Fabric price group 1	No cost	Specify fabric color number.
	• Fabric price group 2	+\$ 30	Specify fabric color number.
	• Fabric price group 3	+\$ 99	Specify fabric color number.
	• Fabric price group 4	+\$123	Specify fabric color number.
	• Fabric price group 5	+\$170	Specify fabric color number.
	• Fabric price group 6	+\$216	Specify fabric color number.
	• Fabric price group 7	+\$255	Specify fabric color number.
	• Fabric price group 8	+\$375	Specify fabric color number.
	• Fabric price group 9	+\$480	Specify fabric color number.
• Fabric price group 10	+\$585	Specify fabric color number.	
• Leather price group	+\$565	Specify leather color number.	
• Customer's Own Material (COM) or Customer's Own Leather (COL)	+\$ 45	▶ See <i>Surface Materials Reference Manual</i> .	
• Perforation of leather seat and back	+\$ 65	Add suffix P to the style number and specify leather color number.	
• Fire Code Seating (FCS) on applicable models	+\$ 80	Specify <i>with fire code seating</i> .	
• Soil-retardant treatment applied to upholstery fabric	+\$ 17	▶ Pages 142–145 Specify <i>with soil-retardant treatment</i> .	
	Base		
	• Customiz stain on wood	+\$ 24	Specify <i>with Customiz stain</i> . ▶ See <i>Surface Materials Reference Manual</i> .
Casters	• 2"-diameter, soft, dual-wheel	+\$ 18	Specify <i>with soft casters</i> .



For Canadian Pricing
Multiply U.S. Price by 1.38.
▶ See page 1 for details.

Specification Information

Enclosed Upholstered Arms



Open Wood Arms with Upholstered Arm Caps



Description	Style Number	U.S. Base Price	Style Number	U.S. Base Price
High-Back				
Manual-height adjustment	0644W	\$1119	0643W	\$1042
Pneumatic-height adjustment	0644WN	\$1179	0643WN	\$1102
Knee tilt with pneumatic height adjustment and seat angle adjustment and upright back lock	0644WK	\$1239	0643WK	\$1162

Enclosed Upholstered Arms



Open Wood Arms with Upholstered Arm Caps



Description	Style Number	U.S. Base Price	Style Number	U.S. Base Price
Low-Back				
Manual-height adjustment	0634W	\$1056	0633W	\$ 982
Pneumatic-height adjustment	0634WN	\$1116	0633WN	\$1042
Knee tilt with pneumatic height adjustment and seat angle adjustment and upright back lock	0634WK	\$1176	0633WK	\$1102

Additional guest chairs that match Gentry wood desk chairs are available.
▶ See page 70



 **For Canadian Pricing**
Multiply U.S. Price by 1.38.
▶ See page 1 for details.

Gentry Desk Chairs

Thermoplastic Models



Standard Includes		Required to Specify
<ul style="list-style-type: none"> ▶ Need help? Product details, page 48 	<ul style="list-style-type: none"> • Back tension control • Swivel-tilt control • Upholstery: fabric price group 1 • Five-arm base: black metal with black plastic base caps • Column: black only • 2"-diameter, hard-composition, dual-wheel casters: black only 	<ul style="list-style-type: none"> 1 Style number 2 Fabric color number for upholstery 3 Options, if selected (see below) ▶ See <i>Surface Materials</i>, page 136.

Options	U.S. Price	Required to Specify
Surface Materials Upholstery <ul style="list-style-type: none"> • Fabric price group 1 • Fabric price group 2 • Fabric price group 3 • Fabric price group 4 • Fabric price group 5 • Fabric price group 6 • Fabric price group 7 • Fabric price group 8 • Fabric price group 9 • Fabric price group 10 • Leather price group • Customer's Own Material (COM) or Customer's Own Leather (COL) • Perforation of leather seat and back • Fire Code Seating (FCS) on applicable models • Soil-retardant treatment applied to upholstery fabric 	<ul style="list-style-type: none"> No cost +\$ 30 +\$ 99 +\$123 +\$170 +\$216 +\$255 +\$375 +\$480 +\$585 +\$565 +\$ 45 +\$ 65 +\$ 80 +\$ 17 	<ul style="list-style-type: none"> Specify fabric color number. Specify fabric color number. Specify fabric color number. Specify fabric color number. Specify fabric color number. Specify fabric color number. Specify fabric color number. Specify fabric color number. Specify fabric color number. Specify fabric color number. Specify leather color number. ▶ See <i>Surface Materials Reference Manual</i>. Add suffix P to the style number and specify leather color number. Specify <i>with fire code seating</i>. ▶ Pages 142–145 Specify <i>with soil-retardant treatment</i>.
Castors <ul style="list-style-type: none"> • 2"-diameter, soft, dual-wheel 	<ul style="list-style-type: none"> +\$ 18 	<ul style="list-style-type: none"> Specify <i>with soft casters</i>.



For Canadian Pricing
 Multiply U.S. Price by 1.38.
 ▶ See page 1 for details.

Specification Information

Enclosed Upholstered Arms



Description	Style Number	U.S. Base Price
-------------	--------------	-----------------

High-Back

Manual-height adjustment	0644B	\$1034
Pneumatic-height adjustment	0644BN	\$1094
Knee tilt with pneumatic height adjustment and two-position, front-tilt lock	0644BK	\$1154

Enclosed Upholstered Arms



Open Thermoplastic Arms



Description	Style Number	U.S. Base Price	Style Number	U.S. Base Price
-------------	--------------	-----------------	--------------	-----------------

Low-Back

Manual-height adjustment	0634B	\$ 971	0632B	\$767
Pneumatic-height adjustment	0634BN	\$1031	0632BN	\$827
Knee tilt with pneumatic height adjustment and two-position, front-tilt lock	0634BK	\$1091	0632BK	\$887



For Canadian Pricing
Multiply U.S. Price by 1.38.
▶ See page 1 for details.



Guest Seating

Alcove	56
Alerion	58
Collaboration	60
England	64
Escapade	66
Gentry	70
Mansfield	72
Mingle	76
Oriana	80
Snodgrass	82
Terrazzo	86
Topaz	90

Alcove

Alcove is a contemporary guest chair with upholstered seat and back.

Frame is European beech wood.

Back and seat are fully upholstered.

Arms are one-piece solid wood construction and form a gentle curve to provide comfortable seating.

Upholstered seat features a webbed panel construction.

Stretcher rails provide additional support.

Legs are solid wood.

Glides are 1/2" in diameter.

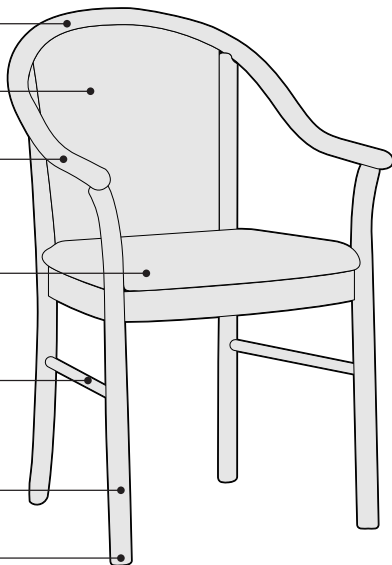

Surface Materials

Upholstery

- Fabric
- Fabric with soil-retardant treatment (option)
- Leather

Frame

- European Beech
- Tip: Wood finishes applied to beech will match the color of stains applied to oak, walnut, or cherry but will not have the same natural grain.*

Glides

- Stainless steel only

All Steelcase seating with standard upholstery fabrics complies with requirements of the BIFMA First Generation Voluntary Upholstered Furniture Flammability Standard, as well as the State of California Technical Bulletins 116 and 117. All standard seating is labeled to be in compliance with California TB116/117.

Programs & Services

► See the *Surface Materials Reference Manual* for further detail about programs and services offered for seating.

The Customer's Own Material (COM) Program

offers the opportunity for customers to select fabrics that are not offered through the standard Steelcase surface materials program for use on Steelcase products. Through the COM program, Steelcase will test your materials for application on Steelcase products. Once approved, you can place your order. Steelcase will facilitate the entire ordering process and give you a production schedule. Steelcase will order the COM fabric directly from the textile manufacturer. For up-to-date information regarding fabric test results for all COM fabrics and details regarding yardage requirements for most Seating lines, visit the COM Web site. To locate the COM Web site:

- Visit www.steelcase.com
- Click on "Knowledge & Design"
- Select "Customer's Own Material"

Soil retardants are treatments that provide long-term soil and stain resistance to a fabric without affecting the shade or the integrity of the fabric. The following Steelcase Textiles are available pre-treated with soil retardant. (You do not need to select the soil-retardant option for these fabrics and incur the \$17 upcharge.)

- Canzoné
- Cavalcade
- Jacks
- Link
- Régis
- Roulette
- Spyder
- Sweepstakes

Soil-retardant treatment is available on all other seating fabrics at an additional \$17 U.S. per seating unit. To order this option, please select "Soil-Retardant Treatment" under "Optional Accessories."

For soil-retardant treatment on COMs, please select "Soil-Retardant Treatment" under "Optional Accessories." Minimums or additional yardage may be required. Please contact the vendor directly for specific information.

Extended lead times may be necessary for this service.

Contact your Steelcase Sales Service representative at 1.888.STEELCASE (1.888.783.3522).

Fire Codes

► See pages 142–145 for upholstery fabrics available for use with FCS modification.

Steelcase offers Fire Code Seating modification (FCS) on nearly all seating models. The most rigorous fire codes in the nation have been developed in California, and the Steelcase FCS modification is designed to meet those codes. Fire Code Seating (FCS) indicates that a product is constructed to meet the strict fire code requirements of high public occupancy areas such as theaters, meeting rooms, and lobbies. The FCS standards will meet both the State of California Home Furnishing Technical Bulletin 133 (Cal TB 133) and Boston Fire Code (BFC). Boston adopted the California Home Furnishing Technical Bulletin TB 133 test standard in 1992.

Local codes may have special requirements for upholstery.

Resources

Alcove Brochure
Form number S3012

Quick Delivery Handbook
Form number S3408

Casegoods and Seating Delivered in 12 Days
Form number S3461

Actual Dimensions

Overall depth	22"
Overall width	22 1/2"
Overall height	33 1/2"
Seat depth	16 1/4"
Seat width	16"
Back width	15 1/2"
Back height	17"
Width between arms	16 1/2"
Seat to floor height	18 3/8"
Arm height from floor	25"



Standard Includes	Required to Specify
<ul style="list-style-type: none"> ▶ Need help? Product details, page 56 • Frame: European Beech • Upholstery: fabric price group 1 • 1/2"-diameter glides: stainless steel only 	<ol style="list-style-type: none"> 1 Style number 2 Wood color number for frame 3 Fabric color number for upholstery 4 Options, if selected (see below) <ul style="list-style-type: none"> ▶ See <i>Surface Materials</i>, page 136.

Options	U.S. Price	Required to Specify
Surface Materials		
Upholstery		
• Fabric price group 1	No cost	Specify fabric color number.
• Fabric price group 2	+\$ 20	Specify fabric color number.
• Fabric price group 3	+\$ 45	Specify fabric color number.
• Fabric price group 4	+\$ 70	Specify fabric color number.
• Fabric price group 5	+\$ 85	Specify fabric color number.
• Fabric price group 6	+\$100	Specify fabric color number.
• Fabric price group 7	+\$125	Specify fabric color number.
• Fabric price group 8	+\$160	Specify fabric color number.
• Fabric price group 9	+\$200	Specify fabric color number.
• Fabric price group 10	+\$260	Specify fabric color number.
• Leather price group	+\$375	Specify leather color number.
• Customer's Own Material (COM) or Customer's Own Leather (COL)	+\$ 15	▶ See <i>Surface Materials Reference Manual</i> .
• Fire Code Seating (FCS) on applicable models	+\$ 80	Specify with <i>fire code seating</i> .
• Soil-retardant treatment applied to upholstery fabric	+\$ 17	▶ Pages 142–145 Specify with <i>soil-retardant treatment</i> .
Wood		
• Customiz stain on wood	+\$ 24	Specify with <i>Customiz stain</i> . ▶ See <i>Surface Materials Reference Manual</i> .

Specification Information	
Style Number	U.S. Base Price
G20	\$511
.	.
.	.



For Canadian Pricing
 Multiply U.S. Price by 1.38.
 ▶ See page 1 for details.

Alerion

Alerion chairs feature a curved back and gracefully sloping arms and convey a quiet sophistication that compliments both transitional and contemporary interiors.

Frame is maple.

Back may be fully upholstered or furnished with solid maple spindles.

Arms are one-piece, solid maple construction; open style arms curve gently for comfortable seating.

Upholstered seat features a webbed panel construction.

Legs are maple.

Glides are 1/2" diameter.

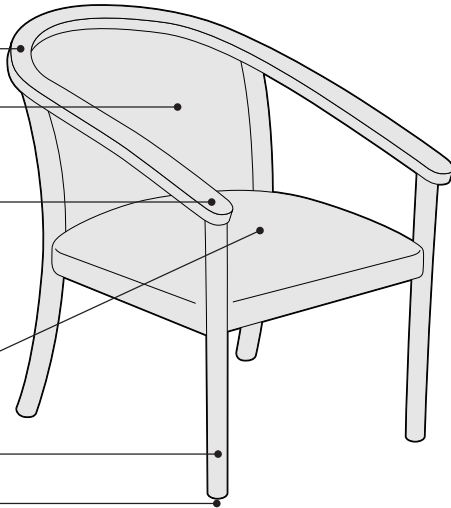

Surface Materials

Upholstery

- Vinyl
- Fabric
- Fabric with soil-retardant treatment (option)
- Leather

Frame

- Maple
- Tip: Finishes applied to maple will match the color of stains applied to oak, walnut, or cherry but will not show the same natural grain.*
- Customiz stain on wood (option)

Glides

- Stainless steel only

All Steelcase seating with standard upholstery fabrics complies with requirements of the BIFMA First Generation Voluntary Upholstered Furniture Standard, as well as State of California Technical Bulletins 116 and 117. All standard seating is labeled to be in compliance with California TB116/117.

Programs & Services

► See the *Surface Materials Reference Manual* for further detail about programs and services offered for seating.

The Customer's Own Material (COM) Program

offers the opportunity for customers to select fabrics that are not offered through the standard Steelcase surface materials program for use on Steelcase products. Through the COM program, Steelcase will test your materials for application on Steelcase products. Once approved, you can place your order. Steelcase will facilitate the entire ordering process and give you a production schedule. Steelcase will order the COM fabric directly from the textile manufacturer. For up-to-date information regarding fabric test results for all COM fabrics and details regarding yardage requirements for most Seating lines, visit the COM Web site. To locate the COM Web site:

- Visit www.steelcase.com
- Click on "Knowledge & Design"
- Select "Customer's Own Material"

Soil retardants are treatments that provide long-term soil and stain resistance to a fabric without affecting the shade or the integrity of the fabric. The following Steelcase Textiles are available pre-treated with soil retardant. (You do not need to select the soil-retardant option for these fabrics and incur the \$17 upcharge.)

- Canzoné
- Cavalcade
- Jacks
- Link
- Regis
- Roulette
- Spyder
- Sweepstakes

Soil-retardant treatment is available on all other seating fabrics at an additional \$17 U.S. per seating unit. To order this option, please select "Soil-Retardant Treatment" under "Optional Accessories."

For soil-retardant treatment on COMs, please select "Soil-Retardant Treatment" under "Optional Accessories." Minimums or additional yardage may be required. Please contact the vendor directly for specific information.

Extended lead times may be necessary for this service.

Contact your Steelcase Sales Service representative at 1.888.STEELCASE (1.888.783.3522).

Fire Codes

► See pages 142–145 for upholstery fabrics available for use with FCS modification.

Steelcase offers Fire Code Seating modification (FCS) on nearly all seating models. The most rigorous fire codes in the nation have been developed in California, and the Steelcase FCS modification is designed to meet those codes. Fire Code Seating (FCS) indicates that a product is constructed to meet the strict fire code requirements of high public occupancy areas such as theaters, meeting rooms, and lobbies. The FCS standards will meet both the State of California Home Furnishing Technical Bulletin 133 (Cal TB 133) and Boston Fire Code (BFC). Boston adopted the California Home Furnishing Technical Bulletin TB 133 test standard in 1992.

Local codes may have special requirements for upholstery.

Resources

Alerion Brochure
Form number S11075

Quick Delivery Handbook
Form number S3408

Casegoods and Seating Delivered in 12 Days
Form number S3461

Actual Dimensions

Overall depth	24 ³ / ₄ "
Overall width	24"
Overall height	29 ⁷ / ₈ "
Seat depth	16 ¹ / ₂ "
Seat width	20 ¹ / ₄ "
Back width	17"
Back height	12"
Width between arms	20"
Seat to floor height	19"
Arm height from floor	27"



Standard Includes	Required to Specify
<ul style="list-style-type: none"> ▶ Need help? Product details, page 58 • Frame: maple • Upholstery: fabric price group 1 • Glides: stainless steel only 	<ol style="list-style-type: none"> 1 Style number 2 Fabric color number for upholstery 3 Wood color number for frame 4 Options, if selected (see below) <ul style="list-style-type: none"> ▶ See <i>Surface Materials</i>, page 136.

Surface Materials	Options	U.S. Price	Required to Specify
	Upholstery		
	• Fabric price group 1	No cost	Specify fabric color number.
	• Fabric price group 2	+\$ 20	Specify fabric color number.
	• Fabric price group 3	+\$ 45	Specify fabric color number.
	• Fabric price group 4	+\$ 70	Specify fabric color number.
	• Fabric price group 5	+\$100	Specify fabric color number.
	• Fabric price group 6	+\$144	Specify fabric color number.
	• Fabric price group 7	+\$170	Specify fabric color number.
	• Fabric price group 8	+\$250	Specify fabric color number.
	• Fabric price group 9	+\$320	Specify fabric color number.
	• Fabric price group 10	+\$390	Specify fabric color number.
	• Leather price group for upholstered back chairs	+\$375	Specify leather color number.
	• Leather price group for spindle back chairs	+\$200	Specify leather color number.
	• Customer's Own Material (COM) or Customer's Own Leather (COL)	+\$ 26	▶ See <i>Surface Materials Reference Manual</i> .
	• Fire Code Seating (FCS) on applicable models	+\$ 80	Specify with <i>fire code seating</i> and specify leather color number.
	• Soil-retardant treatment applied to upholstery fabric	+\$ 17	▶ Pages 142–145 Specify with <i>soil-retardant treatment</i> .
	Frame		
	• Customiz stain on wood	+\$ 24	Specify with <i>Customiz stain</i> . ▶ See <i>Surface Materials Reference Manual</i> .



Specification Information

Style Number	U.S. Base Price
--------------	-----------------

Upholstered Back

0701	\$788
------	-------

Spindle Back

0702	\$830
------	-------

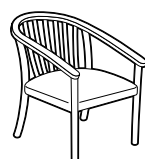

For Canadian Pricing
 Multiply U.S. Price by 1.38.
 ▶ See page 1 for details.

Collaboration

Collaboration guest chairs, designed by Dennie Pimental and John Duffy, have a classic design that is ideal for conference room, reception area, and dining room seating, or as guest seating in a workstation. A family of arm inserts are available to create a variety of different visual details.

Upholstered arm caps are available.

Maple inserts can match or contrast with frame color.

Back and seat are fully upholstered.

Upholstered seat features a webbed panel construction.

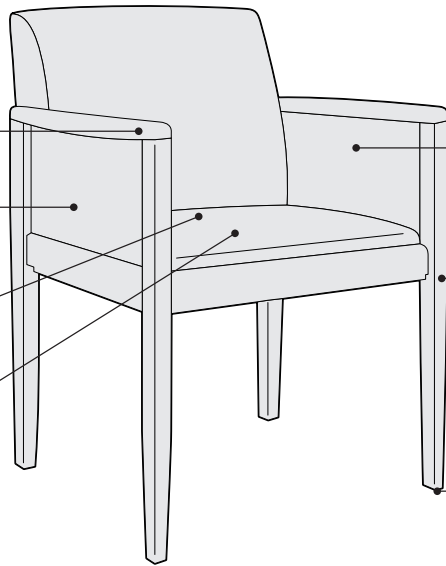

Arms may be enclosed with upholstery or hardwood inserts, or left open.

Frame is solid maple.

Glides are 1/2" diameter.

Product Details

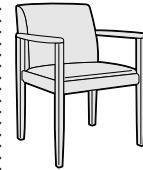

Open-arm chair is the simplest variation in the Collaboration family.

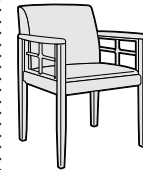

Mullion chair inserts divide the arm space with vertical and horizontal elements.

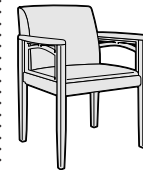

Arcade chair inserts introduce an arched motif.

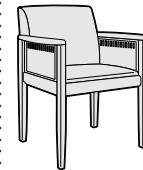

Eyelet chair inserts create rhythm with a slotted pattern.

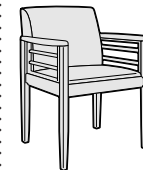

Ladder chair inserts establish a strong horizontal direction.

Actual Dimensions

Overall depth	24 1/4"
Overall width	22 1/2"
Overall height	31 1/2"
Seat depth	17"
Seat width	18 3/4"
Back width	18 3/4"
Back height	13 3/4"
Width between arms	18 3/4"
Seat to floor height	18"
Arm height from floor	25 1/2"

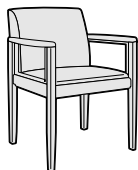

Reveal chair inserts lightly frame the arm space.

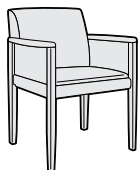

Upholstered inserts enclose the arms with fabric-covered panels.

All inserts are factory-installed.

All chairs are available with plain hardwood arms or upholstered arm caps.

Surface Materials

Upholstery

- Fabric
- Fabric with soil-retardant treatment (option)
- Leather

Frame

- Maple
- Tip: Wood finishes applied to maple will match the color of stains applied to oak, walnut, or cherry but will not show the same natural grain.*
- Customiz stain (option)

Inserts

- Maple
- Customiz stain (option)

Glides

- Stainless steel only

All Steelcase seating with standard upholstery fabrics complies with requirements of the BIFMA First Generation Voluntary Upholstered Furniture Standard, as well as State of California Technical Bulletins 116 and 117. All standard seating is labeled to be in compliance with California TB116/117.

Programs & Services

▶ See the *Surface Materials Reference Manual* for further detail about programs and services offered for seating.

The Customer's Own Material (COM) Program

offers the opportunity for customers to select fabrics that are not offered through the standard Steelcase surface materials program for use on Steelcase products. Through the COM program, Steelcase will test your materials for application on Steelcase products. Once approved, you can place your order. Steelcase will facilitate the entire ordering process and give you a production schedule. Steelcase will order the COM fabric directly from the textile manufacturer. For up-to-date information regarding fabric test results for all COM fabrics and details regarding yardage requirements for most Seating lines, visit the COM Web site. To locate the COM Web site:

- Visit www.steelcase.com
- Click on "Knowledge & Design"
- Select "Customer's Own Material"

Soil retardants are treatments that provide long-term soil and stain resistance to a fabric without affecting the shade or the integrity of the fabric. The following Steelcase Textiles are available pre-treated with soil retardant. (You do not need to select the soil-retardant option for these fabrics and incur the \$17 upcharge.)

- Canzoné
- Cavalcade
- Jacks
- Link
- Regis
- Roulette
- Spyder
- Sweepstakes

Soil-retardant treatment is available on all other seating fabrics at an additional \$17 U.S. per seating unit. To order this option, please select "Soil-Retardant Treatment" under "Optional Accessories."

For soil-retardant treatment on COMs, please select "Soil-Retardant Treatment" under "Optional Accessories." Minimums or additional yardage may be required. Please contact the vendor directly for specific information.

Extended lead times may be necessary for this service.

Contact your Steelcase Sales Service representative at 1.888.STEELCASE (1.888.783.3522).

Fire Codes

▶ See pages 142–145 for upholstery fabrics available for use with FCS modification.

Steelcase offers Fire Code Seating modification (FCS) on nearly all seating models. The most rigorous fire codes in the nation have been developed in California, and the Steelcase FCS modification is designed to meet those codes. Fire Code Seating (FCS) indicates that a product is constructed to meet the strict fire code requirements of high public occupancy areas such as theaters, meeting rooms, and lobbies. The FCS standards will meet both the State of California Home Furnishing Technical Bulletin 133 (Cal TB 133) and Boston Fire Code (BFC). Boston adopted the California Home Furnishing Technical Bulletin TB 133 test standard in 1992.

Local codes may have special requirements for upholstery.

Resources

Collaboration Brochure
Form number S11078

Chairs for People at Work
Form number S11347

Quick Delivery Handbook
Form number S3408

Casegoods and Seating Delivered in 12 Days
Form number S3461

Collaboration Guest Chairs





	Standard Includes	Required to Specify
<ul style="list-style-type: none"> ▶ Need help? Product details, page 60 	<ul style="list-style-type: none"> • Frame: maple • Upholstery on seat and back: fabric price group 1 • Inserts, if selected: maple wood or upholstery • Glides: stainless steel only 	<ol style="list-style-type: none"> 1 Style number 2 Fabric color number for upholstery 3 Wood color number for frame 4 Wood color number for insert, if selected 5 Options, if selected (see below) <ul style="list-style-type: none"> ▶ See <i>Surface Materials</i>, page 136.



	Options	U.S. Price	Required to Specify
Surface Materials	Upholstery		
	<ul style="list-style-type: none"> • Fabric price group 1 • Fabric price group 2 • Fabric price group 3 • Fabric price group 4 • Fabric price group 5 • Fabric price group 6 • Fabric price group 7 • Fabric price group 8 • Fabric price group 9 • Fabric price group 10 • Leather price group • Customer's Own Material (COM) or Customer's Own Leather (COL) • Fire Code Seating (FCS) on applicable models • Soil-retardant treatment applied to upholstery fabric 	<ul style="list-style-type: none"> No cost +\$ 20 +\$ 45 +\$ 70 +\$100 +\$144 +\$170 +\$250 +\$320 +\$390 +\$375 +\$ 26 +\$ 80 +\$ 17 	<ul style="list-style-type: none"> Specify fabric color number. Specify fabric color number. Specify fabric color number. Specify fabric color number. Specify fabric color number. Specify fabric color number. Specify fabric color number. Specify fabric color number. Specify fabric color number. Specify fabric color number. Specify leather color number. ▶ See <i>Surface Materials Reference Manual</i>. Specify with fire code seating. ▶ Pages 142–145 Specify with soil-retardant treatment.
	Frame		
	<ul style="list-style-type: none"> • Customiz stain on wood 	<ul style="list-style-type: none"> +\$ 24 	<ul style="list-style-type: none"> Specify with Customiz stain. ▶ See <i>Surface Materials Reference Manual</i>.





For Canadian Pricing
 Multiply U.S. Price by 1.38.
 ▶ See page 1 for details.

Specification Information

Open			Mullion	
				
Description	Style Number	U.S. Base Price	Style Number	U.S. Base Price
Wood arms	120	\$690	120B	\$765
Upholstered arm caps	120C	\$720	120CB	\$795

Arcade			Eyelet	
				
Description	Style Number	U.S. Base Price	Style Number	U.S. Base Price
Wood arms	120D	\$765	120E	\$765
Upholstered arm caps	120CD	\$795	120CE	\$795

Ladder			Reveal	
				
Description	Style Number	U.S. Base Price	Style Number	U.S. Base Price
Wood arms	120L	\$765	120R	\$765
Upholstered arm caps	120CL	\$795	120CR	\$795

Upholstered Insert				
				
Description	Style Number	U.S. Base Price		
Wood arms	120U	\$765		
Upholstered arm caps	120CU	\$795		



For Canadian Pricing
 Multiply U.S. Price by 1.38.
 ▶ See page 1 for details.

England

England chair, designed by Burt England, is lightweight, comfortable, and durable. The flowing lines of the chair provide an aesthetically pleasing appearance for transitional and contemporary settings.

Back and seat are fully upholstered.

Arms may be enclosed with upholstery or left open.

Upholstered seat features a webbed panel construction.

Arms and front legs are formed by a continuous ribbon of maple.

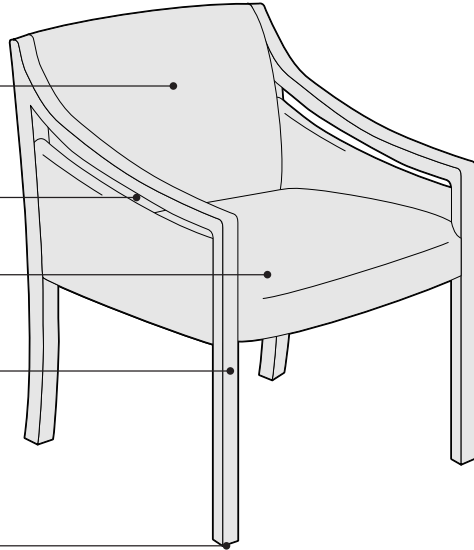

Glides are 1/2" diameter.

Surface Materials

Upholstery

- Vinyl
- Fabric
- Fabric with soil-retardant treatment (option)
- Leather

Frame

- Maple

Tip: Wood finishes applied to maple will match the color of stains applied to oak, walnut, or cherry but will not show the same natural grain.

- Customiz stain on wood (option)

Glides

- Stainless steel only

All Steelcase seating with standard upholstery fabrics complies with requirements of the BIFMA First Generation Voluntary Upholstered Furniture Standard, as well as State of California Technical Bulletins 116 and 117. All standard seating is labeled to be in compliance with California TB116/117.

Programs & Services

► See the *Surface Materials Reference Manual* for further detail about programs and services offered for seating.

The Customer's Own Material (COM) Program

offers the opportunity for customers to select fabrics that are not offered through the standard Steelcase surface materials program for use on Steelcase products. Through the COM program, Steelcase will test your materials for application on Steelcase products. Once approved, you can place your order. Steelcase will facilitate the entire ordering process and give you a production schedule. Steelcase will order the COM fabric directly from the textile manufacturer. For up-to-date information regarding fabric test results for all COM fabrics and details regarding yardage requirements for most Seating lines, visit the COM Web site. To locate the COM Web site:

- Visit www.steelcase.com
- Click on "Knowledge & Design"
- Select "Customer's Own Material"

Soil retardants are treatments that provide long-term soil and stain resistance to a fabric without affecting the shade or the integrity of the fabric. The following Steelcase Textiles are available pre-treated with soil retardant. (You do not need to select the soil-retardant option for these fabrics and incur the \$17 upcharge.)

- Canzoné
- Cavalcade
- Jacks
- Link
- Regis
- Roulette
- Spyder
- Sweepstakes

Soil-retardant treatment is available on all other seating fabrics at an additional \$17 U.S. per seating unit. To order this option, please select "Soil-Retardant Treatment" under "Optional Accessories."

For soil-retardant treatment on COMs, please select "Soil-Retardant Treatment" under "Optional Accessories." Minimums or additional yardage may be required. Please contact the vendor directly for specific information.

Extended lead times may be necessary for this service.

Contact your Steelcase Sales Service Representative at 1.888.STEELCASE (1.888.783.3522).

Fire Codes

► See pages 142–145 for upholstery fabrics available for use with FCS modification.

Steelcase offers Fire Code Seating modification (FCS) on nearly all seating models. The most rigorous fire codes in the nation have been developed in California, and the Steelcase FCS modification is designed to meet those codes. Fire Code Seating (FCS) indicates that a product is constructed to meet the strict fire code requirements of high public occupancy areas such as theaters, meeting rooms, and lobbies. The FCS standards will meet both the State of California Home Furnishing Technical Bulletin 133 (Cal TB 133) and Boston Fire Code (BFC). Boston adopted the California Home Furnishing Technical Bulletin TB 133 test standard in 1992.

Fire code approval:

England enclosed-arm model 0113 is available in the following fabrics only: Leather Vinyl

Local codes may have special requirements for upholstery.

Resources

England Brochure
Form number S3007

Quick Delivery Handbook
Form number S3408

Casegoods and Seating Delivered in 12 Days
Form number S3461

Actual Dimensions

	Open arms	Enclosed arms
Overall depth	24 1/4"	24 1/4"
Overall width	22 1/4"	22 1/4"
Overall height	32 1/2"	32 1/2"
Seat depth	18 1/2"	18 1/2"
Seat width	20 3/4"	19 3/4"
Back width	20 3/4"	19 3/4"
Back height	15 3/4"	15 3/4"
Width between arms	19 3/4"	19 3/4"
Seat to floor height	18 1/2"	18 1/2"
Arm height from floor	24 3/4"	24 3/4"

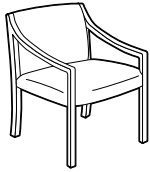

Standard Includes		Required to Specify
<ul style="list-style-type: none"> ▶ Need help? Product details, page 64 	<ul style="list-style-type: none"> • Frame: maple • Upholstery: fabric price group 1 • Glides: stainless steel only 	<ol style="list-style-type: none"> 1 Style number 2 Fabric color number for upholstery 3 Wood color number for frame 4 Options, if selected (see below) <ul style="list-style-type: none"> ▶ See <i>Surface Materials</i>, page 136.

Options	U.S. Price	Required to Specify
Surface Materials		
Upholstery		
<ul style="list-style-type: none"> • Fabric price group 1 • Fabric price group 2 • Fabric price group 3 • Fabric price group 4 • Fabric price group 5 • Fabric price group 6 • Fabric price group 7 • Fabric price group 8 • Fabric price group 9 • Fabric price group 10 • Leather price group for open-arm chairs • Leather price group for enclosed-arm chairs • Customer's Own Material (COM) or Customer's Own Leather (COL) • Fire Code Seating (FCS) on applicable models • Soil-retardant treatment applied to upholstery fabric 	<ul style="list-style-type: none"> No cost +\$ 20 +\$ 45 +\$ 70 +\$100 +\$144 +\$170 +\$250 +\$320 +\$390 +\$375 +\$565 +\$ 26 +\$ 80 +\$ 17 	<ul style="list-style-type: none"> Specify fabric color number. Specify fabric color number. Specify fabric color number. Specify fabric color number. Specify fabric color number. Specify fabric color number. Specify fabric color number. Specify fabric color number. Specify fabric color number. Specify fabric color number. Specify leather color number. Specify leather color number. <ul style="list-style-type: none"> ▶ See <i>Surface Materials Reference Manual</i>. <ul style="list-style-type: none"> Specify with <i>fire code seating</i>. ▶ Pages 142–145 Specify with <i>soil-retardant treatment</i>.
Frame		
<ul style="list-style-type: none"> • Customiz stain on wood 	<ul style="list-style-type: none"> +\$ 24 	<ul style="list-style-type: none"> Specify with <i>Customiz stain</i>. ▶ See <i>Surface Materials Reference Manual</i>.

Guest

Specification Information

Open Arms		Enclosed Arms	
Style Number	U.S. Base Price	Style Number	U.S. Base Price
0114	\$905	0113	\$980



For Canadian Pricing
 Multiply U.S. Price by 1.38.
 ▶ See page 1 for details.

Escapade

Escapade contemporary guest chairs are available with upholstered or wood slat backs.

Frame is European beech wood.

Back is fully upholstered front and back or with vertical wood slats.

Stretcher rails provide additional support.

Legs are solid wood.

Glides are 1/2" in diameter.

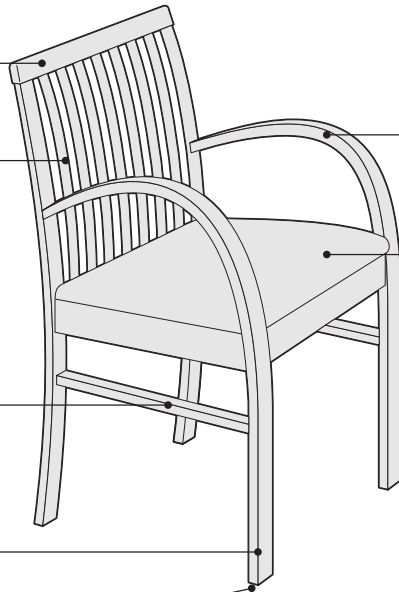

Arms have an open arch that flows into the front legs.

Upholstered seat features a webbed panel construction.

Product Details



Two models are available—upholstered back or vertical-slat wood back.

Actual Dimensions

Overall depth	22"
Overall width	23 1/2"
Overall height	35"
Seat depth	17 1/2"
Seat width	21 1/2"
Back width	20 1/4"
Back height	16 3/4"
Width between arms	19"
Seat to floor height	18 1/4"
Arm height from floor	28 1/2"

Surface Materials

Upholstery

- Fabric
- Fabric with soil-retardant treatment (option)
- Leather

Frame

- European Beech
- Tip: Wood finishes applied to beech will match the color of stains applied to oak, walnut, or cherry but will not have the same natural grain.*

Glides

- Stainless steel only

All Steelcase seating with standard upholstery fabrics

complies with requirements of the BIFMA First Generation Voluntary Upholstered Furniture Flammability Standard, as well as the State of California Technical Bulletins 116 and 117. All standard seating is labeled to be in compliance with California TB116/117.

Programs & Services

▶ See the *Surface Materials Reference Manual* for further detail about programs and services offered for seating.

The Customer's Own Material (COM) Program

offers the opportunity for customers to select fabrics that are not offered through the standard Steelcase surface materials program for use on Steelcase products. Through the COM program, Steelcase will test your materials for application on Steelcase products. Once approved, you can place your order. Steelcase will facilitate the entire ordering process and give you a production schedule. Steelcase will order the COM fabric directly from the textile manufacturer. For up-to-date information regarding fabric test results for all COM fabrics and details regarding yardage requirements for most Seating lines, visit the COM Web site. To locate the COM Web site:

- Visit www.steelcase.com
- Click on "Knowledge & Design"
- Select "Customer's Own Material"

Soil retardants are treatments that provide long-term soil and stain resistance to a fabric without affecting the shade or the integrity of the fabric. The following Steelcase Textiles are available pre-treated with soil retardant. (You do not need to select the soil-retardant option for these fabrics and incur the \$17 upcharge.)

- Canzoné
- Cavalcade
- Jacks
- Link
- Regis
- Roulette
- Spyder
- Sweepstakes

Soil-retardant treatment is available on all other seating fabrics at an additional \$17 U.S. per seating unit. To order this option, please select "Soil-Retardant Treatment" under "Optional Accessories."

For soil-retardant treatment on COMs, please select "Soil-Retardant Treatment" under "Optional Accessories." Minimums or additional yardage may be required. Please contact the vendor directly for specific information.

Extended lead times may be necessary for this service.

Contact your Steelcase Sales Service representative at 1.888.STEELCASE (1.888.783.3522).

Fire Codes

▶ See pages 142–145 for upholstery fabrics available for use with FCS modification.

Steelcase offers Fire Code Seating modification (FCS) on nearly all seating models. The most rigorous fire codes in the nation have been developed in California, and the Steelcase FCS modification is designed to meet those codes. Fire Code Seating (FCS) indicates that a product is constructed to meet the strict fire code requirements of high public occupancy areas such as theaters, meeting rooms, and lobbies. The FCS standards will meet both the State of California Home Furnishing Technical Bulletin 133 (Cal TB 133) and Boston Fire Code (BFC). Boston adopted the California Home Furnishing Technical Bulletin TB 133 test standard in 1992.

Local codes may have special requirements for upholstery.

Resources

Escapade Brochure
Form number S11074

Chairs for People at Work
Form number S11347

Quick Delivery Handbook
Form number S3408



Casegoods and Seating Delivered in 12 Days
Form number S3461

Escapade Guest Chairs



Standard Includes		Required to Specify
<ul style="list-style-type: none"> ▶ Need help? Product details, page 66 	<ul style="list-style-type: none"> • Frame: European Beech • Slat back, if selected: European Beech • Upholstery for seat and cushioned back, if selected: fabric price group 1 • 1/2"-diameter glides: stainless steel only 	<ol style="list-style-type: none"> 1 Style number 2 Wood color number for frame 3 Fabric color number for upholstery 4 Options, if selected (see below) <ul style="list-style-type: none"> ▶ See <i>Surface Materials</i>, page 136.

Options	U.S. Price	Required to Specify
Surface Materials		
Upholstery <ul style="list-style-type: none"> • Fabric price group 1 • Fabric price group 2 • Fabric price group 3 • Fabric price group 4 • Fabric price group 5 • Fabric price group 6 • Fabric price group 7 • Fabric price group 8 • Fabric price group 9 • Fabric price group 10 • Leather price group for slat-back chair • Leather price group for upholstered-back chair • Customer's Own Material (COM) or Customer's Own Leather (COL) • Fire Code Seating (FCS) on applicable models • Soil-retardant treatment applied to upholstery fabric 	No cost +\$ 20 +\$ 45 +\$ 70 +\$100 +\$144 +\$170 +\$250 +\$320 +\$390 +\$200 +\$375 +\$ 26 +\$ 80 +\$ 17	Specify fabric color number. Specify fabric color number. Specify fabric color number. Specify fabric color number. Specify fabric color number. Specify fabric color number. Specify fabric color number. Specify fabric color number. Specify fabric color number. Specify fabric color number. Specify leather color number. Specify leather color number. ▶ See <i>Surface Materials Reference Manual</i> . Specify with fire code seating. ▶ Pages 142–145 Specify with soil-retardant treatment.
Wood <ul style="list-style-type: none"> • Customiz stain on wood 	+\$ 24	Specify with Customiz stain. ▶ See <i>Surface Materials Reference Manual</i> .

Specification Information			
Chair with Wood Slat Back		Chair with Upholstered Cushioned Back	
			
• Style Number	• U.S. Base Price	• Style Number	• U.S. Base Price
G23	\$756	G22	\$714



For Canadian Pricing
 Multiply U.S. Price by 1.38.
 ▶ See page 1 for details.



For Canadian Pricing
Multiply U.S. Price by 1.38.
▶ See page 1 for details.

Gentry

Guest Chair

Gentry chairs, designed by Arnie Dammermann, provide contemporary styling with a distinctive design that features clean, simple lines and natural contours.

▶ See Gentry desk chairs, page 48.

Back is fully upholstered.

Arms are one-piece, solid maple construction; open style arms curve gently for comfortable seating.

Upholstered seat features a webbed panel construction.

Legs are maple.

Glides are 1/2" diameter.

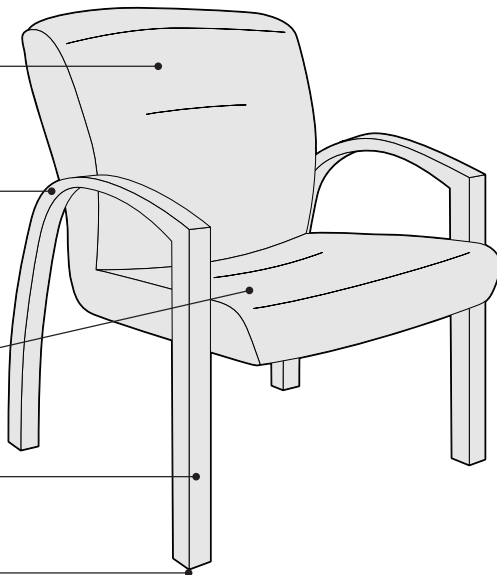

Surface Materials

Seat and back

- Vinyl
- Fabric
- Fabric with soil-retardant treatment (option)
- Leather
- Perforated leather on seat and back (option)

Frame

- Maple
- Customiz stain on wood (option)

Tip: Finishes applied to maple will match the color of stains applied to oak, walnut, or cherry but will not show the same natural grain.

Glides

- Stainless steel only

All Steelcase seating with standard upholstery fabrics complies with requirements of the BIFMA First Generation Voluntary Upholstered Furniture Standard, as well as State of California Technical Bulletins 116 and 117. All standard seating is labeled to be in compliance with California TB116/117.

Programs & Services

▶ See the *Surface Materials Reference Manual* for further detail about programs and services offered for seating.

The Customer's Own Material (COM) Program

offers the opportunity for customers to select fabrics that are not offered through the standard Steelcase surface materials program for use on Steelcase products. Through the COM program, Steelcase will test your materials for application on Steelcase products. Once approved, you can place your order. Steelcase will facilitate the entire ordering process and give you a production schedule. Steelcase will order the COM fabric directly from the textile manufacturer. For up-to-date information regarding fabric test results for all COM fabrics and details regarding yardage requirements for most Seating lines, visit the COM Web site. To locate the COM Web site:

- Visit www.steelcase.com
- Click on "Knowledge & Design"
- Select "Customer's Own Material"

Soil retardants are treatments that provide long-term soil and stain resistance to a fabric without affecting the shade or the integrity of the fabric. The following Steelcase Textiles are available pre-treated with soil retardant. (You do not need to select the soil-retardant option for these fabrics and incur the \$17 upcharge.)

- Canzoné
- Cavalcade
- Jacks
- Link
- Regis
- Roulette
- Spyder
- Sweepstakes

Soil-retardant treatment is available on all other seating fabrics at an additional \$17 U.S. per seating unit. To order this option, please select "Soil-Retardant Treatment" under "Optional Accessories."

For soil-retardant treatment on COMs, please select "Soil-Retardant Treatment" under "Optional Accessories." Minimums or additional yardage may be required. Please contact the vendor directly for specific information.

Extended lead times may be necessary for this service.

Contact your Steelcase Sales Service representative at 1.888.STEELCASE (1.888.783.3522).

Fire Codes

▶ See pages 142–145 for upholstery fabrics available for use with FCS modification.

Steelcase offers Fire Code Seating modification (FCS) on nearly all seating models. The most rigorous fire codes in the nation have been developed in California, and the Steelcase FCS modification is designed to meet those codes. Fire Code Seating (FCS) indicates that a product is constructed to meet the strict fire code requirements of high public occupancy areas such as theaters, meeting rooms, and lobbies. The FCS standards will meet both the State of California Home Furnishing Technical Bulletin 133 (Cal TB 133) and Boston Fire Code (BFC). Boston adopted the California Home Furnishing Technical Bulletin TB 133 test standard in 1992.

Local codes may have special requirements for upholstery.

Resources

Gentry Brochure

Form number S11076

Chairs for People at Work

Form number S11347

Quick Delivery Handbook

Form number S3408

Casegoods and Seating Delivered in 12 Days

Form number S3461

Actual Dimensions

Overall depth	27 1/2"
Overall width	24"
Overall height	33 3/4"
Seat depth	16 1/2"
Seat width	20"
Back width	21"
Back height	19"
Width between arms	19 1/2"
Seat to floor height	17 1/2"
Arm height from floor	24 1/2"

Gentry Guest Chair

Wood Frame

Gentry Guest Chair
Wood Frame



Standard Includes		Required to Specify
<ul style="list-style-type: none"> ▶ Need help? Product details, page 70 	<ul style="list-style-type: none"> • Frame: maple • Upholstery: fabric price group 1 • Glides: stainless steel only 	<ol style="list-style-type: none"> 1 Style number 2 Fabric color number for upholstery 3 Wood color number for frame 4 Options, if selected (see below) <ul style="list-style-type: none"> ▶ See <i>Surface Materials</i>, page 136.

Options	U.S. Price	Required to Specify
Surface Materials	Upholstery	
	<ul style="list-style-type: none"> • Fabric price group 1 • Fabric price group 2 • Fabric price group 3 • Fabric price group 4 • Fabric price group 5 • Fabric price group 6 • Fabric price group 7 • Fabric price group 8 • Fabric price group 9 • Fabric price group 10 • Leather price group • Customer's Own Material (COM) or Customer's Own Leather (COL) • Perforation of leather seat and back • Fire Code Seating (FCS) on applicable models • Soil-retardant treatment applied to upholstery fabric 	<ul style="list-style-type: none"> No cost +\$ 20 +\$ 45 +\$ 70 +\$100 +\$144 +\$170 +\$250 +\$320 +\$390 +\$375 +\$ 26 +\$ 65 +\$ 80 +\$ 17
	Frame	
	<ul style="list-style-type: none"> • Customiz stain on wood 	<ul style="list-style-type: none"> Specify fabric color number. Specify fabric color number. Specify fabric color number. Specify fabric color number. Specify fabric color number. Specify fabric color number. Specify fabric color number. Specify fabric color number. Specify fabric color number. Specify leather color number ▶ See <i>Surface Materials Reference Manual</i>. Add suffix P to the style number and specify leather color number. Specify <i>with fire code seating</i>. ▶ Pages 142–145 Specify <i>with soil-retardant treatment</i>. Specify <i>with Customiz stain</i>. ▶ See <i>Surface Materials Reference Manual</i>.

Guest

Specification Information



Description	Style Number	U.S. Base Price
Open wood arms	0612W	\$733



For Canadian Pricing
Multiply U.S. Price by 1.38.
▶ See page 1 for details.

Mansfield

Guest Seating

Mansfield guest chairs provide a cost-effective solution for conference or reception seating where traditional Chippendale styling is desired.

Welting on back is standard.

Camel back enhances traditional styling.

Product Details



Matching wood guest chair is also available.

Brass tack accenting is optional on chairs with upholstered seat and back.

Arms are maple with upholstered arm rests.

Upholstered seat features a webbed panel construction.

Stretcher rails provide additional support.

Glides are 1/2" diameter.

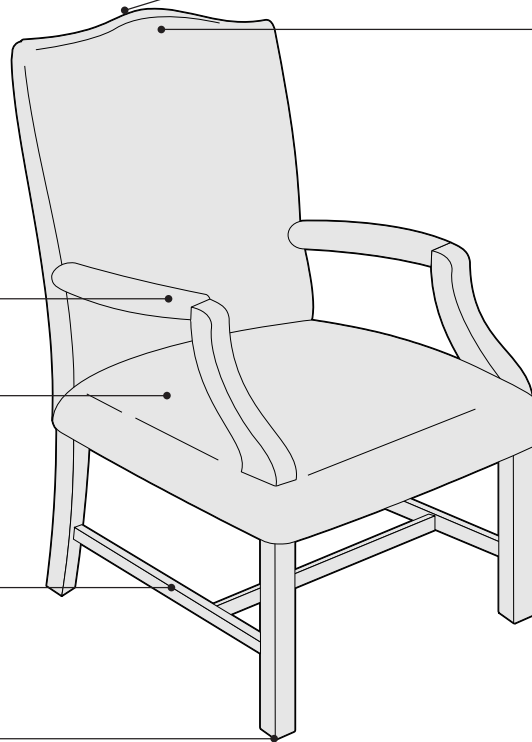

Actual Dimensions

	Upholstered Guest Chairs	Wood Guest Chairs
Overall depth	27"	24½"
Overall width	24½"	26"
Overall height	37½"	40½"
Seat depth	19½"	18"
Seat width	19"	19½"
Back width	21"	18½"
Back height from seat	22½"	24"
Width between arms	19"	19¼"
Seat to floor height	19"	19"
Arm height from floor	24½"	24½"

Surface Materials

Upholstery

- Vinyl
- Fabric
- Fabric with soil-retardant treatment (option)
- Leather

Frame

- Maple

Tip: Finishes applied to maple will match the color of stains applied to oak, walnut, or cherry, but will not show the same natural grain.

- Customiz stain on wood (option)

Glides

- Stainless steel only

All Steelcase seating with standard upholstery fabrics

complies with requirements of the BIFMA First Generation Voluntary Upholstered Furniture Standard, as well as State of California Technical Bulletins 116 and 117. All standard seating is labeled to be in compliance with California TB116/117.

Programs & Services

▶ See the *Surface Materials Reference Manual* for further detail about programs and services offered for seating.

The Customer's Own Material (COM) Program

offers the opportunity for customers to select fabrics that are not offered through the standard Steelcase surface materials program for use on Steelcase products. Through the COM program, Steelcase will test your materials for application on Steelcase products. Once approved, you can place your order. Steelcase will facilitate the entire ordering process and give you a production schedule. Steelcase will order the COM fabric directly from the textile manufacturer. For up-to-date information regarding fabric test results for all COM fabrics and details regarding yardage requirements for most Seating lines, visit the COM Web site. To locate the COM Web site:

- Visit www.steelcase.com
- Click on "Knowledge & Design"
- Select "Customer's Own Material"

Soil retardants are treatments that provide long-term soil and stain resistance to a fabric without affecting the shade or the integrity of the fabric. The following Steelcase Textiles are available pre-treated with soil retardant. (You do not need to select the soil-retardant option for these fabrics and incur the \$17 upcharge.)

- Canzoné
- Cavalcade
- Jacks
- Link
- Regis
- Roulette
- Spyder
- Sweepstakes

Soil-retardant treatment is available on all other seating fabrics at an additional \$17 U.S. per seating unit. To order this option, please select "Soil-Retardant Treatment" under "Optional Accessories."

For soil-retardant treatment on COMs, please select "Soil-Retardant Treatment" under "Optional Accessories." Minimums or additional yardage may be required. Please contact the vendor directly for specific information.

Extended lead times may be necessary for this service.

Contact your Steelcase Sales Service representative at 1.888.STEELCASE (1.888.783.3522).

Fire Codes

▶ See pages 142–145 for upholstery fabrics available for use with FCS modification.

Steelcase offers Fire Code Seating modification (FCS) on nearly all seating models. The most rigorous fire codes in the nation have been developed in California, and the Steelcase FCS modification is designed to meet those codes. Fire Code Seating (FCS) indicates that a product is constructed to meet the strict fire code requirements of high public occupancy areas such as theaters, meeting rooms, and lobbies. The FCS standards will meet both the State of California Home Furnishing Technical Bulletin 133 (Cal TB 133) and Boston Fire Code (BFC). Boston adopted the California Home Furnishing Technical Bulletin TB 133 test standard in 1992.

Local codes may have special requirements for upholstery.

Resources

Mansfield Brochure
Form number S10485

Mansfield Guest Chairs

Upholstered Chair

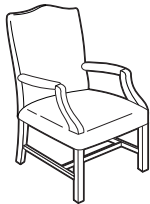

Standard Includes	Required to Specify
<ul style="list-style-type: none"> ▶ Need help? Product details, page 72 • Frame: maple • Upholstery: fabric price group 1 • Glides: stainless steel only 	<ol style="list-style-type: none"> 1 Style number 2 Fabric color number for upholstery 3 Wood color number for frame 4 Options, if selected (see below) <ul style="list-style-type: none"> ▶ See <i>Surface Materials</i>, page 136.

Surface Materials	Options	U.S. Price	Required to Specify
	Upholstery <ul style="list-style-type: none"> • Fabric price group 1 • Fabric price group 2 • Fabric price group 3 • Fabric price group 4 • Fabric price group 5 • Fabric price group 6 • Fabric price group 7 • Fabric price group 8 • Fabric price group 9 • Fabric price group 10 • Leather price group • Customer's Own Material (COM) or Customer's Own Leather (COL) • Fire Code Seating (FCS) on applicable models • Soil-retardant treatment applied to upholstery fabric 	No cost +\$ 30 +\$ 99 +\$123 +\$170 +\$216 +\$255 +\$375 +\$480 +\$585 +\$835 +\$ 45	Specify fabric color number. Specify fabric color number. Specify fabric color number. Specify fabric color number. Specify fabric color number. Specify fabric color number. Specify fabric color number. Specify fabric color number. Specify fabric color number. Specify fabric color number. Specify leather color number. ▶ See <i>Surface Materials Reference Manual</i> .
	Brass tacks <ul style="list-style-type: none"> • Brass tack accenting 	+\$ 35	Add suffix B to the style number.
	Frame <ul style="list-style-type: none"> • Customiz stain 	+\$ 24	Specify with <i>Customiz stain</i> . ▶ See <i>Surface Materials Reference Manual</i> .

Specification Information

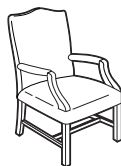

• Style Number	• U.S. Base Price
142	\$639



For Canadian Pricing
 Multiply U.S. Price by 1.38.
 ▶ See page 1 for details.

Mansfield Guest Chairs

Wood Chair

Mansfield Guest Chairs
Wood Chair



Standard Includes		Required to Specify
<ul style="list-style-type: none"> ▶ Need help? Product details, page 72 	<ul style="list-style-type: none"> • Frame: maple • Upholstery: fabric price group 1 • Glides: stainless steel only 	<ol style="list-style-type: none"> 1 Style number 2 Fabric color number for upholstery 3 Wood color number for frame 4 Options, if selected (see below) <ul style="list-style-type: none"> ▶ See <i>Surface Materials</i>, page 136.

Options	U.S. Price	Required to Specify
Surface Materials		
Upholstery		
• Fabric price group 1	No cost	Specify fabric color number.
• Fabric price group 2	+\$ 20	Specify fabric color number.
• Fabric price group 3	+\$ 45	Specify fabric color number.
• Fabric price group 4	+\$ 70	Specify fabric color number.
• Fabric price group 5	+\$ 85	Specify fabric color number.
• Fabric price group 6	+\$100	Specify fabric color number.
• Fabric price group 7	+\$125	Specify fabric color number.
• Fabric price group 8	+\$160	Specify fabric color number.
• Fabric price group 9	+\$200	Specify fabric color number.
• Fabric price group 10	+\$260	Specify fabric color number.
• Leather price group	+\$200	Specify leather color number.
• Customer's Own Material (COM) or Customer's Own Leather (COL)	+\$ 15	▶ See <i>Surface Materials Reference Manual</i> .
• Fire Code Seating (FCS) on applicable models	+\$ 80	Specify with fire code seating. ▶ Pages 142–145
• Soil-retardant treatment applied to upholstery fabric	+\$ 17	Specify with soil-retardant treatment.
Frame		
• Customiz stain	+\$ 24	Specify with Customiz stain. ▶ See <i>Surface Materials Reference Manual</i> .

Guest

Specification Information



Style Number	U.S. Base Price
144	\$623



For Canadian Pricing
Multiply U.S. Price by 1.38.
▶ See page 1 for details.

Mingle

Mingle guest chairs, designed by Bill Schacht and Lynda Chesser, have a tailored appearance that is sophisticated and pure in design, yet simple in scale. Mingle's design addresses a broad set of applications from an open plan systems environment to a closed office setting.

Exposed plywood back panel provides enhanced lumbar support to achieve a high level of comfort.

Seat is either upholstered or wood. Upholstered seat features a webbed-panel construction.

Back legs and seat frame are metal for additional strength and durability. Legs are standard in black. Nickel powdercoat is available as an option.

Foot cap is standard with nickel finish.

Arms taper to flow into front legs.

Glides are 1/2" diameter on front legs and 1" diameter on back legs.

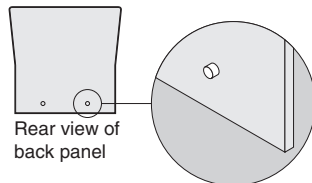
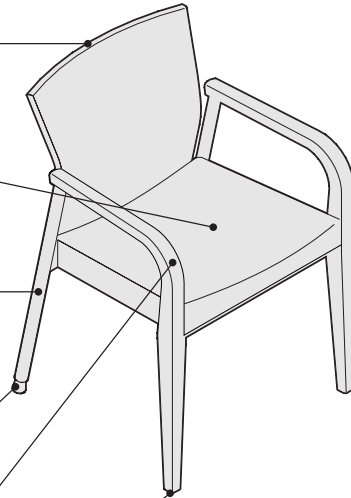

Metal button fasteners located at bottom of back panel secure seat and back attachment while providing an additional element of design.

Actual Dimensions

Overall depth	22 1/8"
Overall width	22 1/4"
Overall height	32"
Seat depth	17 1/2"
Seat width	17 7/8"
Back width	17 1/4"
Back height	14"
Width between arms	19"
Seat to floor height	18 1/2"
Arm height from floor	25 1/2"

Surface Materials

Seat

- Fabric
- Fabric with soil-retardant treatment (option)
- Leather
- Wood

Tip: Only 3792 Black Walnut is available for wood seats.

Back legs

- Black
- Nickel (option)

Back, arms, and front legs

- Plywood
- Customiz stain (option)

Metal button fasteners

- Nickel color only

Foot caps on back legs

- Nickel color only

Glides

- Stainless steel on front legs
- Nylon on back legs

All Steelcase seating with standard upholstery fabrics complies with requirements of the BIFMA First Generation Voluntary Upholstered Furniture Standard, as well as State of California Technical Bulletins 116 and 117. All standard seating is labeled to be in compliance with California TB116/117.

Programs & Services

► See the *Surface Materials Reference Manual* for further detail about programs and services offered for seating.

The Customer's Own Material (COM) Program

offers the opportunity for customers to select fabrics that are not offered through the standard Steelcase surface materials program for use on Steelcase products. Through the COM program, Steelcase will test your materials for application on Steelcase products. Once approved, you can place your order. Steelcase will facilitate the entire ordering process and give you a production schedule. Steelcase will order the COM fabric directly from the textile manufacturer. For up-to-date information regarding fabric test results for all COM fabrics and details regarding yardage requirements for most Seating lines, visit the COM Web site. To locate the COM Web site:

- Visit www.steelcase.com
- Click on "Knowledge & Design"
- Select "Customer's Own Material"

Soil retardants are treatments that provide long-term soil and stain resistance to a fabric without affecting the shade or the integrity of the fabric. The following Steelcase Textiles are available pre-treated with soil retardant. (You do not need to select the soil-retardant option for these fabrics and incur the \$17 upcharge.)

- Canzoné
- Cavalcade
- Jacks
- Link
- Regis
- Roulette
- Spyder
- Sweepstakes

Soil-retardant treatment is available on all other seating fabrics at an additional \$17 U.S. per seating unit. To order this option, please select "Soil-Retardant Treatment" under "Optional Accessories."

For soil-retardant treatment on COMs, please select "Soil-Retardant Treatment" under "Optional Accessories." Minimums or additional yardage may be required. Please contact the vendor directly for specific information.

Extended lead times may be necessary for this service.

Contact your Steelcase Sales Service representative at 1.888.STEELCASE (1.888.783.3522).

Fire Codes

▶ See pages 142–145 for upholstery fabrics available for use with FCS modification.

Steelcase offers Fire Code Seating modification (FCS) on nearly all seating models. The most rigorous fire codes in the nation have been developed in California, and the Steelcase FCS modification is designed to meet those codes. Fire Code Seating (FCS) indicates that a product is constructed to meet the strict fire code requirements of high public occupancy areas such as theaters, meeting rooms, and lobbies. The FCS standards will meet both the State of California Home Furnishing Technical Bulletin 133 (Cal TB 133) and Boston Fire Code (BFC). Boston adopted the California Home Furnishing Technical Bulletin TB 133 test standard in 1992.

Local codes may have special requirements for upholstery.

Resources

Mingle Brochure
Form number S10880

Mingle Guest Chairs



	Standard Includes	Required to Specify
▶ Need help? Product details, page 76	<ul style="list-style-type: none"> • Back, arms, and front legs: maple • Back legs: black • Seat: upholstered or wood color 3792 Black Walnut • Upholstery, if selected: fabric price group 1 • Glides: stainless steel on front legs, nylon on back legs 	<ol style="list-style-type: none"> 1 Style number 2 Wood color number for frame 3 Fabric color number for upholstery, if selected 4 Options, if selected (see below) <p>▶ See <i>Surface Materials</i>, page 136.</p>

	Options	U.S. Price	Required to Specify
Surface Materials	Upholstery		
	• Fabric price group 1	No cost	Specify fabric color number.
	• Fabric price group 2	+\$ 20	Specify fabric color number.
	• Fabric price group 3	+\$ 45	Specify fabric color number.
	• Fabric price group 4	+\$ 70	Specify fabric color number.
	• Fabric price group 5	+\$ 85	Specify fabric color number.
	• Fabric price group 6	+\$100	Specify fabric color number.
	• Fabric price group 7	+\$125	Specify fabric color number.
	• Fabric price group 8	+\$160	Specify fabric color number.
	• Fabric price group 9	+\$200	Specify fabric color number.
• Fabric price group 10	+\$260	Specify fabric color number.	
• Leather price group	+\$200	Specify fabric color number.	
• Customer's Own Material (COM) or Customer's Own Leather (COL)	+\$ 15	Specify leather color number.	
• Fire Code Seating (FCS) on applicable models	+\$ 80	▶ See <i>Surface Materials Reference Manual</i> .	
• Soil-retardant treatment applied to upholstery fabric	+\$ 17	Specify with fire code seating. ▶ Pages 142–145 Specify with soil-retardant treatment.	
	Frame		
	• Customiz stain on wood	+\$ 24	Specify with Customiz stain. ▶ See <i>Surface Materials Reference Manual</i> .
	Legs		
	• Nickel	+\$ 25	Specify with 7026 Nickel.

Specification Information	
Style Number	U.S. Base Price
Wood Seat	
MNGLBW	\$832
Upholstered Seat	
MNGLB	\$781



For Canadian Pricing
Multiply U.S. Price by 1.38.
▶ See page 1 for details.



For Canadian Pricing
Multiply U.S. Price by 1.38.
▶ See page 1 for details.

Oriana

Oriana, designed by David Jenkins, is an interpretation of early ladder-back and slat-back seating designs. Its classic styling is suitable for both transitional and contemporary interiors.

Back is available in three design variations.

Arms are open.

Frame is maple.

Upholstered seat features a webbed panel construction.

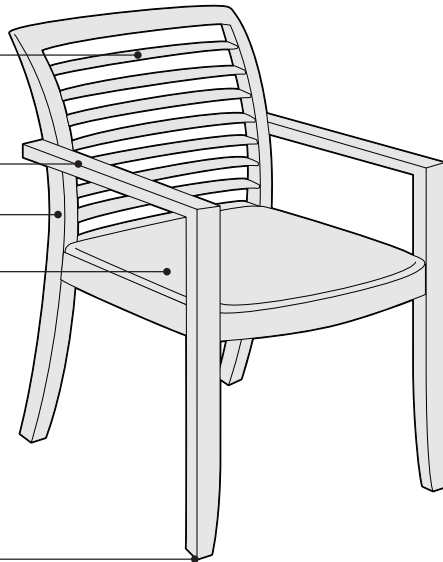

Glides are 1/2" diameter.

Product Details

Back is available with horizontal slats, vertical slats, or closed upholstered construction.

Surface Materials

Upholstery

- Fabric
- Fabric with soil-retardant treatment (option)
- Leather

Frame

- Maple
- Tip: Wood finishes applied to maple will match the color of stains applied to oak, walnut, or cherry but will not show the same natural grain.*

- Customiz stain (option)

Glides

- Stainless steel only

All Steelcase seating with standard upholstery fabrics complies with requirements of the BIFMA First Generation Voluntary Upholstered Furniture Standard, as well as State of California Technical Bulletins 116 and 117. All standard seating is labeled to be in compliance with California TB116/117.

Programs & Services

► See the *Surface Materials Reference Manual* for further detail about programs and services offered for seating.

The Customer's Own Material (COM) Program

offers the opportunity for customers to select fabrics that are not offered through the standard Steelcase surface materials program for use on Steelcase products. Through the COM program, Steelcase will test your materials for application on Steelcase products. Once approved, you can place your order. Steelcase will facilitate the entire ordering process and give you a production schedule. Steelcase will order the COM fabric directly from the textile manufacturer. For up-to-date information regarding fabric test results for all COM fabrics and details regarding yardage requirements for most Seating lines, visit the COM Web site. To locate the COM Web site:

- Visit www.steelcase.com
- Click on "Knowledge & Design"
- Select "Customer's Own Material"

Soil retardants are treatments that provide long-term soil and stain resistance to a fabric without affecting the shade or the integrity of the fabric. The following Steelcase Textiles are available pre-treated with soil retardant. (You do not need to select the soil-retardant option for these fabrics and incur the \$17 upcharge.)

- Canzoné
- Cavalcade
- Jacks
- Link
- Regis
- Roulette
- Spyder
- Sweepstakes

Soil-retardant treatment is available on all other seating fabrics at an additional \$17 U.S. per seating unit. To order this option, please select "Soil-Retardant Treatment" under "Optional Accessories."

For soil-retardant treatment on COMs, please select "Soil-Retardant Treatment" under "Optional Accessories." Minimums or additional yardage may be required. Please contact the vendor directly for specific information.

Extended lead times may be necessary for this service.

Contact your Steelcase Sales Service representative at 1.888.STEELCASE (1.888.783.3522).

Fire Codes

► See pages 142–145 for upholstery fabrics available for use with FCS modification.

Steelcase offers Fire Code Seating modification (FCS) on nearly all seating models. The most rigorous fire codes in the nation have been developed in California, and the Steelcase FCS modification is designed to meet those codes. Fire Code Seating (FCS) indicates that a product is constructed to meet the strict fire code requirements of high public occupancy areas such as theaters, meeting rooms, and lobbies. The FCS standards will meet both the State of California Home Furnishing Technical Bulletin 133 (Cal TB 133) and Boston Fire Code (BFC). Boston adopted the California Home Furnishing Technical Bulletin TB 133 test standard in 1992.

Local codes may have special requirements for upholstery.

Resources

Oriana Brochure
Form number S11079

Actual Dimensions

Overall depth	23 ⁷ / ₈ "
Overall width	23 ¹ / ₄ "
Overall height	34 ³ / ₈ "
Seat depth	17 ⁷ / ₈ "
Seat width	20"
Back width	18"
Back height	15 ⁵ / ₈ "
Width between arms	19"
Seat to floor height	18 ³ / ₄ "
Arm height from floor	25 ³ / ₈ "



Standard Includes		Required to Specify
<ul style="list-style-type: none"> ▶ Need help? Product details, page 80 	<ul style="list-style-type: none"> • Frame: maple • Upholstery: fabric price group 1 • Glides: stainless steel only 	<ol style="list-style-type: none"> 1 Style number 2 Fabric color number for upholstery 3 Wood color number for frame 4 Options, if selected (see below) <ul style="list-style-type: none"> ▶ See <i>Surface Materials</i>, page 136.

Options	U.S. Price	Required to Specify
Surface Materials	Upholstery	
	<ul style="list-style-type: none"> • Fabric price group 1 • Fabric price group 2 • Fabric price group 3 • Fabric price group 4 • Fabric price group 5 • Fabric price group 6 • Fabric price group 7 • Fabric price group 8 • Fabric price group 9 • Fabric price group 10 • Leather price group for slat-back chairs • Leather price group for fully-upholstered chair • Customer's Own Material (COM) or Customer's Own Leather (COL) • Fire Code Seating (FCS) on applicable models • Soil-retardant treatment applied to upholstery fabric 	<ul style="list-style-type: none"> No cost +\$ 20 +\$ 45 +\$ 70 +\$100 +\$144 +\$170 +\$250 +\$320 +\$390 +\$200 +\$375 +\$ 26 +\$ 80 +\$ 17
	Frame	
	<ul style="list-style-type: none"> • Customiz stain on wood 	<ul style="list-style-type: none"> Specify fabric color number. Specify fabric color number. Specify fabric color number. Specify fabric color number. Specify fabric color number. Specify fabric color number. Specify fabric color number. Specify fabric color number. Specify fabric color number. Specify leather color number. Specify leather color number. ▶ See <i>Surface Materials Reference Manual</i>. Specify with <i>fire code seating</i>. ▶ Pages 142–145 Specify with <i>soil-retardant treatment</i>. Specify with <i>Customiz stain</i>. ▶ See <i>Surface Materials Reference Manual</i>.

Guest

Specification Information

Vertical Slat Back		Horizontal Slat Back		Fully Upholstered Back	
Style Number	U.S. Base Price	Style Number	U.S. Base Price	Style Number	U.S. Base Price
0202	\$1064	0204	\$1064	0205	\$1024

 **For Canadian Pricing**
 Multiply U.S. Price by 1.38.
 ▶ See page 1 for details.

Snodgrass 474 Series

Snodgrass, designed by Warren Snodgrass, offers guest and occasional seating of classic simplicity. With a choice of metal or wood frames, Snodgrass has enduring design that is always in style. Guest chairs are suitable for use as occasional seating within team spaces, workstations, offices, or wherever extra seating is required. Snodgrass seating can also be found in the *Seating Specification Guide* (S10553).

Frame is available in monochromatic colors. Polished chrome and wood veneer frames are also available on specific models. See Specifying pages for surface materials availability.

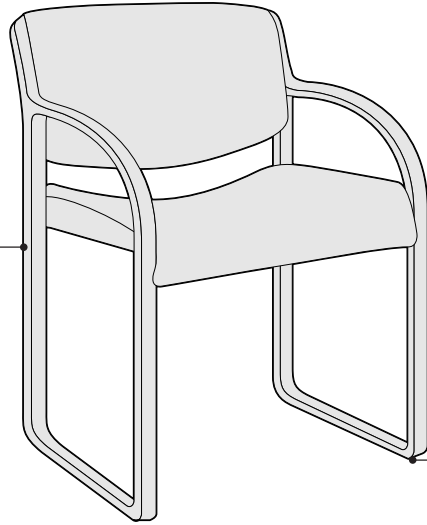

Glides are clear plastic.

Product Details

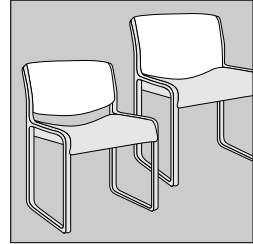

Two back shapes are available, open back or full back.

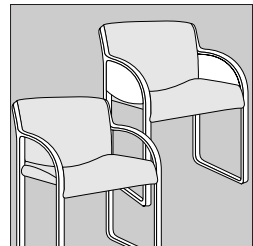

Two arm styles—open and enclosed—are available.

Actual Dimensions

Overall depth	23½"
Overall width	22¾"
Overall height	31½"
Seat depth	21"
Functional seat depth	17½"
Seat width	20"
Back width	20"
Back height	14¼"
Back lumbar height	7"
Width between arms	20"
Seat-to-floor height	18¼"
Arm height from floor	25¼"
Arm height from seat	7"
Seat pan angle	5°
Angle between seat and back	103°

Surface Materials

▶ See surface materials on page 136 for specific availability or refer to the *Surface Materials Reference Manual* for further information.

Upholstery

- Fabric
- Fabric with soil retardant treatment (option)
- Vinyl
- Leather

Frame

- 9201 Polished Chrome
 - Monochromatic color from list of seating plastic color numbers can be applied to the frame.
 - Wood
- Tip: Frames are constructed of solid maple. Finishes applied to maple will match the color of stains applied to oak, walnut, or cherry, but will not show the same natural grain.*

Glides

- Clear plastic

All Steelcase seating with standard upholstery fabrics complies with requirements of the BIFMA First Generation Voluntary Upholstered Furniture Flammability Standard, as well as the State of California Technical Bulletins 116 and 117. All standard seating is labeled to be in compliance with California TB116/117.

Programs & Services

▶ See the *Surface Materials Reference Manual* for further detail about programs and services offered for seating.

The Customer's Own Material (COM) Program

offers the opportunity for customers to select fabrics that are not offered through the standard Steelcase surface materials program for use on Steelcase products. Through the COM program, Steelcase will test your materials for application on Steelcase products. Once approved, you can place your order. Steelcase will facilitate the entire ordering process and give you a production schedule. Steelcase will order the COM fabric directly from the textile manufacturer. For up-to-date information regarding fabric test results for all COM fabrics and details regarding yardage requirements for most Seating lines, visit the COM Web site. To locate the COM Web site:

- Visit www.steelcase.com
- Click on "Knowledge & Design"
- Select "Customer's Own Material"

Soil retardants are treatments that provide long-term soil and stain resistance to a fabric without affecting the shade or the integrity of the fabric. The following Steelcase Textiles are available pre-treated with soil retardant. (You do not need to select the soil-retardant option for these fabrics and incur the \$17 upcharge.)

- Canzoné
- Cavalcade
- Jacks
- Link
- Regis
- Roulette
- Spyder
- Sweepstakes

Soil-retardant treatment is available on all other seating fabrics at an additional \$17 U.S. per seating unit. To order this option, please select "Soil-Retardant Treatment" under "Optional Accessories."

For soil-retardant treatment on COMs, please select "Soil-Retardant Treatment" under "Optional Accessories." Minimums or additional yardage may be required. Please contact the vendor directly for specific information.

Extended lead times may be necessary for this service.

Contact your Steelcase Sales Service representative at 1.888.STEELCASE (1.888.783.3522).

Fire Codes

▶ See pages 142–145 for upholstery fabrics available for use with FCS modification.

Steelcase offers Fire Code Seating modification (FCS) on nearly all seating models. The most rigorous fire codes in the nation have been developed in California, and the Steelcase FCS modification is designed to meet those codes. Fire Code Seating (FCS) indicates that a product is constructed to meet the strict fire code requirements of high public occupancy areas such as theaters, meeting rooms, and lobbies. The FCS standards will meet both the State of California Home Furnishing Technical Bulletin 133 (Cal TB 133) and Boston Fire Code (BFC). Boston adopted the California Home Furnishing Technical Bulletin TB 133 test standard in 1992.

Fire code approval: Snodgrass enclosed-arm model 474427W is available in the following fabrics only: Leather
Vinyl

Local codes may have special requirements for upholstery.

Resources

Snodgrass Brochure
Form number (S11006)

Snodgrass 474 Series Guest Chairs

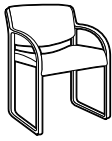

	Standard Includes	Required to Specify
▶ Need help? Product details, page 82	<ul style="list-style-type: none"> • Frame and arms, if selected: 9201 Polished Chrome, monochromatic color, or wood veneer • Upholstery: fabric price group 1 • Glides: clear plastic 	<ol style="list-style-type: none"> 1 Style number 2 Fabric color number for upholstery 3 Monochromatic color number from seating plastic colors for frame, if applicable 4 Wood veneer color number for frame, if applicable 5 Options, if selected (see below) <p>▶ See <i>Surface Materials</i>, page 136.</p>

	Options	U.S. Price	Required to Specify
Surface Materials	Upholstery		
	• Fabric price group 1	No cost	Specify fabric color number.
	• Fabric price group 2	+\$ 20	Specify fabric color number.
	• Fabric price group 3	+\$ 40	Specify fabric color number.
	• Fabric price group 4	+\$ 55	Specify fabric color number.
	• Fabric price group 5	+\$ 70	Specify fabric color number.
	• Fabric price group 6	+\$ 85	Specify fabric color number.
	• Fabric price group 7	+\$100	Specify fabric color number.
	• Fabric price group 8	+\$125	Specify fabric color number.
	• Fabric price group 9	+\$155	Specify fabric color number.
	• Fabric price group 10	+\$175	Specify fabric color number.
	• Leather price group	+\$450	Specify leather color number.
	• Customer's Own Material/Leather (COM/COL)	+\$ 30	▶ See <i>Surface Materials Reference Manual</i> .
• Fire Code Seating (FCS) on applicable models	+\$ 50	Add suffix F to the style number.	
• Soil-retardant treatment applied to upholstery fabric	+\$ 17	▶ Pages 142–145 Specify <i>with soil-retardant treatment</i> .	
	Frame		
	• Customiz stain on wood	+\$ 24	Specify <i>with Customiz stain</i> . ▶ See <i>Surface Materials Reference Manual</i> .



For Canadian Pricing
Multiply U.S. Price by 1.38.
▶ See page 1 for details.

Specification Information

**Open Loop Arms
with Open Back**



• **Style
Number**
:
:
:

• **U.S.
Base
Price**
:
:
:

**Open Loop Arms
With Full Back**



• **Style
Number**
:
:
:

• **U.S.
Base
Price**
:
:
:

**Enclosed Arms
with Full Back**



• **Style
Number**
:
:
:

• **U.S.
Base
Price**
:
:
:

Monochromatic

474419M \$537

474429M \$552

N.A.

Wood

474419W \$829

474429W \$844

474427W \$1030

**Armless
with Open Back**



• **Style
Number**
:
:
:

• **U.S.
Base
Price**
:
:
:

**Armless
with Full Back**



• **Style
Number**
:
:
:

• **U.S.
Base
Price**
:
:
:

Monochromatic

474410M \$505

474420M \$520



For Canadian Pricing
Multiply U.S. Price by 1.38.
▶ See page 1 for details.

Terrazzo

Terrazzo guest chairs, designed by Brian Kane, have a classic and simple styling appropriate for a broad range of applications. A family of factory-installed back designs are available to create a variety of visual statements.

Lattice inserts are available in three designs. Slats are bowed to provide enhanced lumbar support.

Frame is solid maple.

Arms are arched to correspond with the curvature of the chair's back and are gently raised at the front to assist in entering and rising from the chair.

Seat is fully upholstered and features a webbed-panel construction.

Glides are 1/2" diameter.

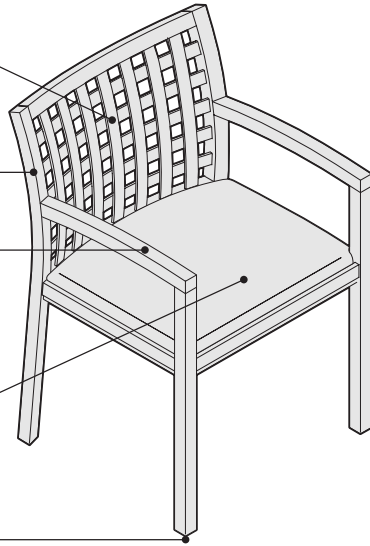

Square lattice back chair



Macintosh lattice back chair



Horizontal lattice back chair

Actual Dimensions

Overall depth	21 ³ / ₄ "
Overall width	21 ¹ / ₄ "
Overall height	32 ¹ / ₄ "
Seat depth	17 ⁷ / ₈ "
Seat width	20"
Back width	21 ¹ / ₄ "
Back height	14"
Width between arms	18 ³ / ₄ "
Seat to floor height	18 ¹ / ₄ "
Arm height from floor	25 ¹ / ₄ "

Product Details

Square lattice back creates a strong grid-like pattern.

Macintosh lattice back introduces a distinctive vertical space.

Horizontal lattice back divides the space with horizontal elements.

Surface Materials

Seat

- Vinyl
- Fabric
- Fabric with soil-retardant treatment (option)
- Leather

Frame and back slats

- Maple
- Tip: Wood finishes applied to maple will match the color of stains applied to oak, walnut, or cherry but will not show the same natural grain.*
- Customiz stain (option)

Glides

- Stainless steel only

All Steelcase seating with standard upholstery fabrics complies with requirements of the BIFMA First Generation Voluntary Upholstered Furniture Standard, as well as State of California Technical Bulletins 116 and 117. All standard seating is labeled to be in compliance with California TB116/117.

Programs & Services

► See the *Surface Materials Reference Manual* for further detail about programs and services offered for seating.

The Customer's Own Material (COM) Program

offers the opportunity for customers to select fabrics that are not offered through the standard Steelcase surface materials program for use on Steelcase products. Through the COM program, Steelcase will test your materials for application on Steelcase products. Once approved, you can place your order. Steelcase will facilitate the entire ordering process and give you a production schedule. Steelcase will order the COM fabric directly from the textile manufacturer. For up-to-date information regarding fabric test results for all COM fabrics and details regarding yardage requirements for most Seating lines, visit the COM Web site. To locate the COM Web site:

- Visit www.steelcase.com
- Click on "Knowledge & Design"
- Select "Customer's Own Material"

Soil retardants are treatments that provide long-term soil and stain resistance to a fabric without affecting the shade or the integrity of the fabric. The following Steelcase Textiles are available pre-treated with soil retardant. (You do not need to select the soil-retardant option for these fabrics and incur the \$17 upcharge.)

- Canzoné
- Cavalcade
- Jacks
- Link
- Regis
- Roulette
- Spyder
- Sweepstakes

Soil-retardant treatment is available on all other seating fabrics at an additional \$17 U.S. per seating unit. To order this option, please select "Soil-Retardant Treatment" under "Optional Accessories."

For soil-retardant treatment on COMs, please select "Soil-Retardant Treatment" under "Optional Accessories." Minimums or additional yardage may be required. Please contact the vendor directly for specific information.

Extended lead times may be necessary for this service.

Contact your Steelcase Sales Service representative at 1.888.STEELCASE (1.888.783.3522).

Fire Codes

▶ See pages 142–145 for upholstery fabrics available for use with FCS modification.

Steelcase offers Fire Code Seating modification (FCS) on nearly all seating models. The most rigorous fire codes in the nation have been developed in California, and the Steelcase FCS modification is designed to meet those codes. Fire Code Seating (FCS) indicates that a product is constructed to meet the strict fire code requirements of high public occupancy areas such as theaters, meeting rooms, and lobbies. The FCS standards will meet both the State of California Home Furnishing Technical Bulletin 133 (Cal TB 133) and Boston Fire Code (BFC). Boston adopted the California Home Furnishing Technical Bulletin TB 133 test standard in 1992.

Local codes may have special requirements for upholstery.

Resources

- Terrazzo Brochure**
Form number S10886
- Chairs for People at Work**
Form number S11347

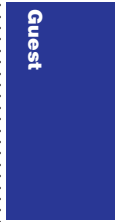

Terrazzo Guest Chairs

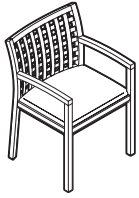

Standard Includes	Required to Specify
<ul style="list-style-type: none"> ▶ Need help? Product details, page 86 • Upholstery on seat: fabric price group 1 • Frame: maple • Lattice slats: maple • Glides: stainless steel only 	<ol style="list-style-type: none"> 1 Style number 2 Fabric color number for upholstery 3 Wood color number for frame 4 Options, if selected (see below) <p>▶ See <i>Surface Materials</i>, page 136.</p>

Options	U.S. Price	Required to Specify
Surface Materials		
Upholstery <ul style="list-style-type: none"> • Fabric price group 1 • Fabric price group 2 • Fabric price group 3 • Fabric price group 4 • Fabric price group 5 • Fabric price group 6 • Fabric price group 7 • Fabric price group 8 • Fabric price group 9 • Fabric price group 10 • Leather price group • Customer's Own Material (COM) or Customer's Own Leather (COL) • Fire Code Seating (FCS) on applicable models • Soil-retardant treatment applied to upholstery fabric 	No cost +\$ 20 +\$ 45 +\$ 70 +\$ 85 +\$100 +\$125 +\$160 +\$200 +\$260 +\$200 +\$ 15 +\$ 80 +\$ 17	Specify fabric color number. Specify fabric color number. Specify fabric color number. Specify fabric color number. Specify fabric color number. Specify fabric color number. Specify fabric color number. Specify fabric color number. Specify fabric color number. Specify leather color number. ▶ See <i>Surface Materials Reference Manual</i> . Specify <i>with fire code seating</i> . ▶ Pages 142–145 Specify <i>with soil-retardant treatment</i> .
Frame <ul style="list-style-type: none"> • Customiz stain on wood 	+\$ 24	Specify <i>with Customiz stain</i> . ▶ See <i>Surface Materials Reference Manual</i> .

Specification Information

Square Lattice Back



• **Style Number**
 • **U.S. Base Price**

TERR1 \$801

Macintosh Lattice Back



• **Style Number**
 • **U.S. Base Price**

TERR2 \$801

Horizontal Lattice Back



• **Style Number**
 • **U.S. Base Price**

TERR3 \$801



For Canadian Pricing
 Multiply U.S. Price by 1.38.
 ▶ See page 1 for details.



For Canadian Pricing
Multiply U.S. Price by 1.38.
▶ See page 1 for details.

Topaz

Topaz offers two chair styles to complement traditional and transitional office environments.

Frame is European Beech.

Back is upholstered and framed in wood. It is available either open or closed.

Arms are open. They are available with either a rectangular or curvilinear design.

Upholstered seat features a webbed panel construction.

Legs are solid wood. Front legs on open back model are carved for traditional detail.

Glides are 1/2" in diameter.

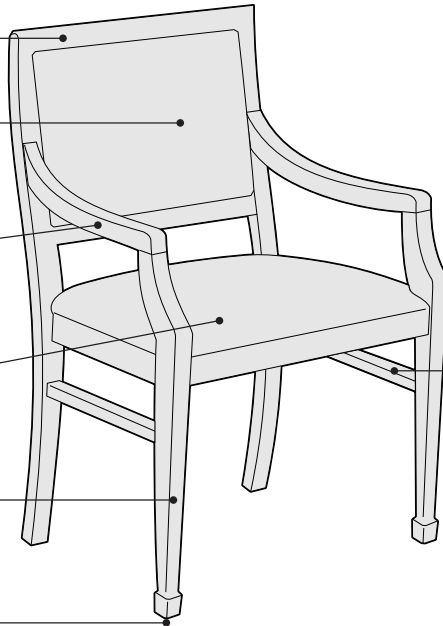

Stretcher rails on open back model provide added support.

Product Details

Two models are available—open back or closed back.

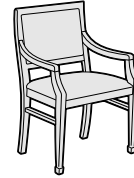

Open-back models have rectangular arms, carved detail on the front legs, and stretcher rails.



Closed-back models have curvilinear arms that flow into the front legs.

Actual Dimensions

	Closed Back	Open Back
Overall depth	20 1/2"	23"
Overall width	22 1/4"	23"
Overall height	32 3/4"	35 1/2"
Seat depth	16"	18"
Seat width	21"	21"
Back width	20 1/2"	19 1/2"
Back height	14 1/2"	17 3/4"
Width between arms	19 1/2"	19 1/2"
Seat to floor height	18 1/4"	18 1/4"
Arm height from floor	25 1/2"	25 1/2"

Surface Materials

Upholstery

- Vinyl
- Fabric
- Fabric with soil-retardant treatment (option)
- Leather

Frame

- European Beech
- Tip: Wood finishes applied to beech will match the color of stains applied to oak, walnut, or cherry but will not have the same natural grain.*

Glides

- Stainless steel only

All Steelcase seating with standard upholstery fabrics complies with requirements of the BIFMA First Generation Voluntary Upholstered Furniture Flammability Standard, as well as the State of California Technical Bulletins 116 and 117. All standard seating is labeled to be in compliance with California TB116/117.

Programs & Services

▶ See the *Surface Materials Reference Manual* for further detail about programs and services offered for seating.

The Customer's Own Material (COM) Program

offers the opportunity for customers to select fabrics that are not offered through the standard Steelcase surface materials program for use on Steelcase products. Through the COM program, Steelcase will test your materials for application on Steelcase products. Once approved, you can place your order. Steelcase will facilitate the entire ordering process and give you a production schedule. Steelcase will order the COM fabric directly from the textile manufacturer. For up-to-date information regarding fabric test results for all COM fabrics and details regarding yardage requirements for most Seating lines, visit the COM Web site. To locate the COM Web site:

- Visit www.steelcase.com
- Click on "Knowledge & Design"
- Select "Customer's Own Material"

Soil retardants are treatments that provide long-term soil and stain resistance to a fabric without affecting the shade or the integrity of the fabric. The following Steelcase Textiles are available pre-treated with soil retardant. (You do not need to select the soil-retardant option for these fabrics and incur the \$17 upcharge.)

- Canzoné
- Cavalcade
- Jacks
- Link
- Regis
- Roulette
- Spyder
- Sweepstakes

Soil-retardant treatment is available on all other seating fabrics at an additional \$17 U.S. per seating unit. To order this option, please select "Soil-Retardant Treatment" under "Optional Accessories."

For soil-retardant treatment on COMs, please select "Soil-Retardant Treatment" under "Optional Accessories." Minimums or additional yardage may be required. Please contact the vendor directly for specific information.

Extended lead times may be necessary for this service.

Contact your Steelcase Sales Service representative at 1.888.STEELCASE (1.888.783.3522).

Fire Codes

▶ See pages 142–145 for upholstery fabrics available for use with FCS modification.

Steelcase offers Fire Code Seating modification (FCS) on nearly all seating models. The most rigorous fire codes in the nation have been developed in California, and the Steelcase FCS modification is designed to meet those codes. Fire Code Seating (FCS) indicates that a product is constructed to meet the strict fire code requirements of high public occupancy areas such as theaters, meeting rooms, and lobbies. The FCS standards will meet both the State of California Home Furnishing Technical Bulletin 133 (Cal TB 133) and Boston Fire Code (BFC). Boston adopted the California Home Furnishing Technical Bulletin TB 133 test standard in 1992.

Local codes may have special requirements for upholstery.

Resources

Topaz Brochure
Form number S11077

Chairs for People at Work
Form number S11347

Quick Delivery Handbook
Form number S3408

Casegoods and Seating Delivered in 12 Days
Form number S3461

Topaz Guest Chairs



Standard Includes		Required to Specify
<ul style="list-style-type: none"> ▶ Need help? Product details, page 90 	<ul style="list-style-type: none"> • Frame: European Beech • Upholstery: fabric price group 1 • 1/2"-diameter glides: stainless steel only 	<ol style="list-style-type: none"> 1 Style number 2 Wood color number for frame 3 Fabric color number for upholstery 4 Options, if selected (see below) <ul style="list-style-type: none"> ▶ See <i>Surface Materials</i>, page 136.

Options	U.S. Price	Required to Specify
Surface Materials		
Upholstery <ul style="list-style-type: none"> • Fabric price group 1 • Fabric price group 2 • Fabric price group 3 • Fabric price group 4 • Fabric price group 5 • Fabric price group 6 • Fabric price group 7 • Fabric price group 8 • Fabric price group 9 • Fabric price group 10 • Leather price group • Customer's Own Material (COM) or Customer's Own Leather (COL) • Fire Code Seating (FCS) on applicable models • Soil-retardant treatment applied to upholstery fabric 	No cost +\$ 20 +\$ 45 +\$ 70 +\$ 85 +\$100 +\$125 +\$160 +\$200 +\$260 +\$375 +\$ 15 +\$ 80 +\$ 17	Specify fabric color number. Specify fabric color number. Specify fabric color number. Specify fabric color number. Specify fabric color number. Specify fabric color number. Specify fabric color number. Specify fabric color number. Specify fabric color number. Specify fabric color number. Specify leather color number. ▶ See <i>Surface Materials Reference Manual</i> . Specify with fire code seating. ▶ Pages 142–145 Specify with soil-retardant treatment.
Wood <ul style="list-style-type: none"> • Customiz stain on wood 	+\$ 24	Specify with Customiz stain. ▶ See <i>Surface Materials Reference Manual</i> .

Specification Information			
Chair with Open Back		Chair with Closed Back	
• Style Number	• U.S. Base Price	• Style Number	• U.S. Base Price
G24	\$679	G26	\$633



For Canadian Pricing
 Multiply U.S. Price by 1.38.
 ▶ See page 1 for details.

Stackable Seating

Company	94
Deck	98

Company

Sculptural grace is captured in this stackable chair of mixed materials. Company, designed by Kirt Martin in Steelcase Wood's Treehouse studio, adds beauty and style to any environment.

Aluminum arms and subframe are standard in black textured paint and available as an option in Nickel paint.

Seat shell is available fully upholstered or wood.

Legs are solid maple.

Glides are 1/2" in diameter.

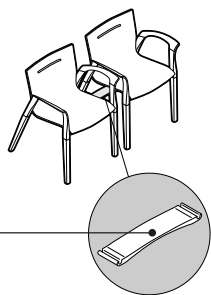
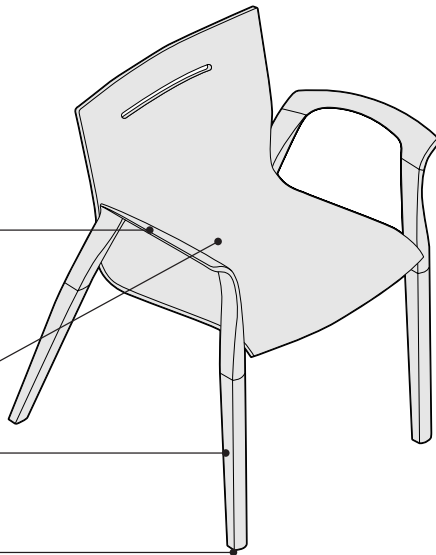

Ganging device is available to link chairs in the field for evenly spaced rows. Spacing between seats of chairs linked with ganging device is 6³/₄". Spacing between arms is 1/4".

Actual Dimensions

Overall depth	24 ¹ / ₂ "
Overall width	24 ³ / ₈ "
Overall height	34"
Seat depth	17"
Seat width	17 ⁷ / ₈ "
Back width	19 ¹ / ₄ "
Back height	15"
Width between arms	19"
Seat to floor height	18 ¹ / ₈ "
Arm height from floor	26 ³ / ₄ "

Product Details

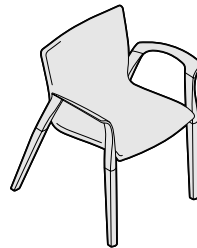

Fully upholstered back and seat

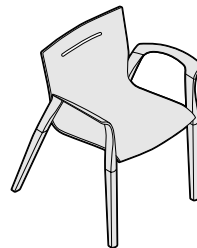

Wood back and seat

Company stackable chairs are available in two styles—fully upholstered back and seat and wood back and seat.

Chairs stack four high.

Surface Materials

Upholstery

- Vinyl
- Fabric
- Fabric with soil-retardant treatment (option)
- Leather

Arms

- 7207 Black
- 7026 Nickel (option)

Back and seat

- Maple
- Upholstery

Legs

- Maple
- Tip: Wood finishes applied to maple will match the color of stains applied to oak, walnut, or cherry but will not have the same natural grain.*
- Customiz stain (option)

Ganging device

- Black plastic only

Glides

- Nickel-plated steel only

All Steelcase seating with standard upholstery fabrics complies with requirements of the BIFMA First Generation Voluntary Upholstered Furniture Flammability Standard, as well as the State of California Technical Bulletins 116 and 117. All standard seating is labeled to be in compliance with California TB116/117.

Programs & Services

► See the *Surface Materials Reference Manual* for further detail about programs and services offered for seating.

The Customer's Own Material (COM) Program

offers the opportunity for customers to select fabrics that are not offered through the standard Steelcase surface materials program for use on Steelcase products. Through the COM program, Steelcase will test your materials for application on Steelcase products. Once approved, you can place your order. Steelcase will facilitate the entire ordering process and give you a production schedule. Steelcase will order the COM fabric directly from the textile manufacturer. For up-to-date information regarding fabric test results for all COM fabrics and details regarding yardage requirements for most Seating lines, visit the COM Web site. To locate the COM Web site:

- Visit www.steelcase.com
- Click on "Knowledge & Design"
- Select "Customer's Own Material"

Soil retardants are treatments that provide long-term soil and stain resistance to a fabric without affecting the shade or the integrity of the fabric. The following Steelcase Textiles are available pre-treated with soil retardant. (You do not need to select the soil-retardant option for these fabrics and incur the \$17 upcharge.)

- Canzoné
- Cavalcade
- Jacks
- Link
- Regis
- Roulette
- Spyder
- Sweepstakes

Soil-retardant treatment is available on all other seating fabrics at an additional \$17 U.S. per seating unit. To order this option, please select "Soil-Retardant Treatment" under "Optional Accessories."

For soil-retardant treatment on COMs, please select "Soil-Retardant Treatment" under "Optional Accessories." Minimums or additional yardage may be required. Please contact the vendor directly for specific information.

Extended lead times may be necessary for this service.

Contact your Steelcase Sales Service representative at 1.888.STEELCASE (1.888.783.3522).

Fire Codes

► See pages 142–145 for upholstery fabrics available for use with FCS modification.

Steelcase offers Fire Code Seating modification (FCS) on nearly all seating models.

The most rigorous fire codes in the nation have been developed in California, and the Steelcase FCS modification is designed to meet those codes. Fire Code Seating (FCS) indicates that a product is constructed to meet the strict fire code requirements of high public occupancy areas such as theaters, meeting rooms, and lobbies. The FCS standards will meet both the State of California Home Furnishing Technical Bulletin 133 (Cal TB 133) and Boston Fire Code (BFC). Boston adopted the California Home Furnishing Technical Bulletin TB 133 test standard in 1992.

Local codes may have special requirements for upholstery.

Resources

Company Brochure
Form number S11197

Chairs for People at Work
Form number S11347

Company Stackable Guest Chairs

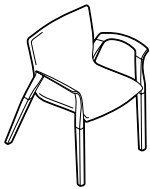

Standard Includes		Required to Specify
<ul style="list-style-type: none"> ▶ Need help? Product details, page 94 	<ul style="list-style-type: none"> • Back and seat: fabric price group 1 or maple • Arms: 7207 Black • Legs: maple • Glides: nickel-plated steel 	<ol style="list-style-type: none"> 1 Style number 2 Fabric color number for upholstery, if selected 3 Wood color number for frame 4 Options, if selected (see below) <ul style="list-style-type: none"> ▶ See <i>Surface Materials</i>, page 136.

Options	U.S. Price	Required to Specify
Surface Materials	Upholstery <ul style="list-style-type: none"> • Fabric price group 1: No cost • Fabric price group 2: +\$ 20 • Fabric price group 3: +\$ 45 • Fabric price group 4: +\$ 70 • Fabric price group 5: +\$ 85 • Fabric price group 6: +\$100 • Fabric price group 7: +\$125 • Fabric price group 8: +\$160 • Fabric price group 9: +\$200 • Fabric price group 10: +\$260 • Leather price group: +\$375 • Customer's Own Material (COM) or Customer's Own Leather (COL): +\$ 15 • Fire Code Seating (FCS) on applicable models: +\$ 80 • Soil-retardant treatment applied to upholstery fabric: +\$ 17 	Specify fabric color number. Specify fabric color number. Specify fabric color number. Specify fabric color number. Specify fabric color number. Specify fabric color number. Specify fabric color number. Specify fabric color number. Specify fabric color number. Specify fabric color number. Specify leather color number. ▶ See <i>Surface Materials Reference Manual</i> .
	Frame <ul style="list-style-type: none"> • Customiz stain on wood: +\$ 24 	Specify with <i>fire code seating</i> . ▶ Pages 142–145 Specify with <i>soil-retardant treatment</i> .
	Arms <ul style="list-style-type: none"> • Nickel: +\$ 25 	Specify with <i>7026 Nickel arms</i> .
Ganging Device	<ul style="list-style-type: none"> • Removable ganging device to link adjacent chairs: black plastic only: +\$ 20 	Add suffix G to the style number.

Specification Information			
Wood Back and Seat		Upholstered Back and Seat	
Style Number	U.S. Base Price	Style Number	U.S. Base Price
CMPY1	\$725	CMPY2	\$670



For Canadian Pricing
 Multiply U.S. Price by 1.38.
 ▶ See page 1 for details.



For Canadian Pricing
Multiply U.S. Price by 1.38.
▶ See page 1 for details.

Deck

Deck, stackable wood guest chairs designed by Brian Kane, combine function with a tailored aesthetic that is bound to become a modern classic.

Back and seat are available fully upholstered, with wood back and upholstered seat or with wood back and wood seat.

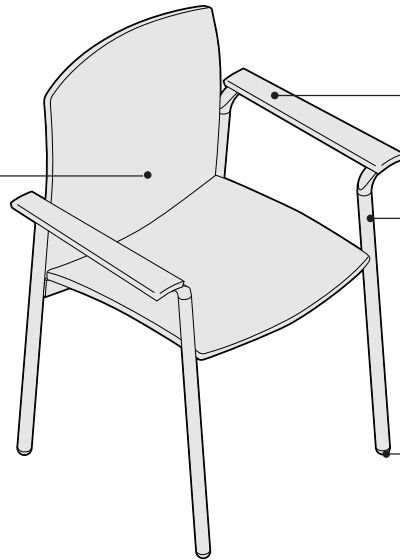

Arms are available as wood or black expanded urethane.

Legs are standard in black textured paint and available as an option in sterling paint.

Glides are 1/2" diameter.

Product Details

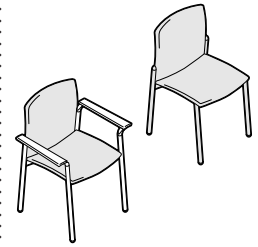

Fully upholstered back and seat

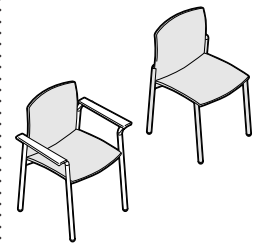

Wood back and seat

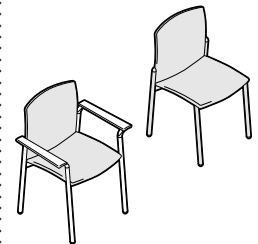

Wood back and upholstered seat

Deck stackable chairs with and without arms

are available in three styles—fully upholstered back and seat, wood back and seat, and wood back with upholstered seat.

Chairs stack five high.

Actual Dimensions

	Guest chair with arms	Guest chair without arms	Stool
Overall depth	21 ⁵ / ₈ "	21 ⁵ / ₈ "	20 ¹ / ₂ "
Overall width	26 ³ / ₈ "	20"	17 ⁷ / ₈ "
Overall height	32 ³ / ₄ "	32 ³ / ₄ "	44 ⁷ / ₈ "
Seat depth	17 ¹³ / ₁₆ "	17 ¹³ / ₁₆ "	15 ⁷ / ₈ "
Seat width	17 ¹³ / ₁₆ "	17 ¹³ / ₁₆ "	17 ⁷ / ₈ "
Back width	17 ¹³ / ₁₆ "	17 ¹³ / ₁₆ "	15"
Back height	17 ¹⁵ / ₁₆ "	17 ¹³ / ₁₆ "	16"
Width between arms	20 ³ / ₈ "	N.A.	N.A.
Seat to floor height	17 ³ / ₄ "	17 ³ / ₄ "	30 ¹ / ₄ "
Arm height from floor	25 ³ / ₁₆ "	N.A.	N.A.

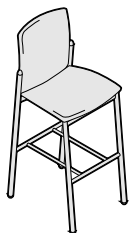

Fully upholstered back and seat

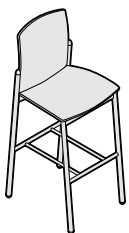

Wood back and seat

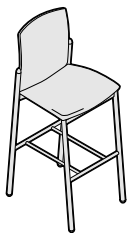

Wood back and upholstered seat

Stools are available fully upholstered, with wood back and seat, or with wood back and upholstered seat.

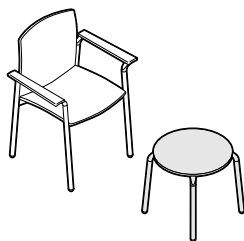

Occasional table is available for use with Deck guest chairs or other wood products. Table is 18" in diameter.

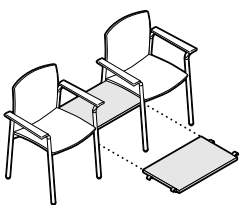

In-line table is used between two Deck guest chairs. It is not freestanding. Table is 15" x 24".

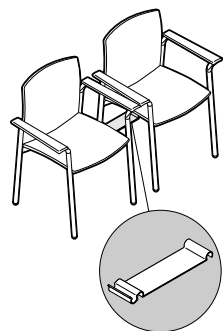

Ganging device is available to link chairs in the field for evenly spaced rows. Spacing between seats of chairs linked with ganging device is 9". Spacing between front of chair arms is 1/2" and spacing between back of chair arms is 2".

Surface Materials

Upholstery

- Vinyl
- Fabric
- Fabric with soil-retardant treatment (option)
- Leather

Legs

- 7207 Black
- 7098 Sterling (option)

Arms

- Expanded urethane
- Wood

Seat

- Wood or upholstered

Back

- Wood or upholstered
- Tip: Wood finishes applied to maple will match the color of stains applied to oak, walnut, or cherry but will not show the same natural grain.*
- Customiz stain (option)

Ganging device

- Black plastic only

Glides

- Plastic to match legs

Occasional and in-line tables

- Wood
- Customiz stain (option)
- Tip: Wood finishes applied to maple tables will match the color of stains applied to oak, walnut, or cherry but will not have the same natural grain pattern. If using tables to match Deck seating, use occasional tables on maple veneer so substrates and grain patterns will match one another. If using tables with other products such as casegoods, use species-specific occasional tables.*

Occasional table legs

- 7207 Black
- 7098 Sterling (option)

All Steelcase seating with standard upholstery fabrics complies with requirements of the BIFMA First Generation Voluntary Upholstered Furniture Standard, as well as State of California Technical Bulletins 116 and 117. All standard seating is labeled to be in compliance with California TB116/117.

Programs & Services

▶ See the *Surface Materials Reference Manual* for further detail about programs and services offered for seating.

The Customer's Own Material (COM) Program

offers the opportunity for customers to select fabrics that are not offered through the standard Steelcase surface materials program for use on Steelcase products. Through the COM program, Steelcase will test your materials for application on Steelcase products. Once approved, you can place your order. Steelcase will facilitate the entire ordering process and give you a production schedule. Steelcase will order the COM fabric directly from the textile manufacturer. For up-to-date information regarding fabric test results for all COM fabrics and details regarding yardage requirements for most Seating lines, visit the COM Web site. To locate the COM Web site:

- Visit www.steelcase.com
- Click on "Knowledge & Design"
- Select "Customer's Own Material"

Soil retardants are treatments that provide long-term soil and stain resistance to a fabric without affecting the shade or the integrity of the fabric. The following Steelcase Textiles are available pre-treated with soil retardant. (You do not need to select the soil-retardant option for these fabrics and incur the \$17 upcharge.)

- Canzoné
- Cavalcade
- Jacks
- Link
- Regis
- Roulette
- Spyder
- Sweepstakes

Soil-retardant treatment is available on all other seating fabrics at an additional \$17 U.S. per seating unit. To order this option, please select "Soil-Retardant Treatment" under "Optional Accessories."

For soil-retardant treatment on COMs, please select "Soil-Retardant Treatment" under "Optional Accessories." Minimums or additional yardage may be required. Please contact the vendor directly for specific information.

Extended lead times may be necessary for this service.

Contact your Steelcase Sales Service representative at 1.888.STEELCASE (1.888.783.3522).

Fire Codes

▶ See pages 142–145 for upholstery fabrics available for use with FCS modification.

Steelcase offers Fire Code Seating modification (FCS) on nearly all seating models. The most rigorous fire codes in the nation have been developed in California, and the Steelcase FCS modification is designed to meet those codes. Fire Code Seating (FCS) indicates that a product is constructed to meet the strict fire code requirements of high public occupancy areas such as theaters, meeting rooms, and lobbies. The FCS standards will meet both the State of California Home Furnishing Technical Bulletin 133 (Cal TB 133) and Boston Fire Code (BFC). Boston adopted the California Home Furnishing Technical Bulletin TB 133 test standard in 1992.

Local codes may have special requirements for upholstery.

Resources

Deck Brochure

Form number S11198

Chairs for People at Work

Form number S11347

Deck Stackable Guest Chairs



	Standard Includes	Required to Specify
▶ Need help? Product details, page 98	<ul style="list-style-type: none"> • Back and seat: fabric price group 1 or maple • Arms, if selected: maple or black urethane • Legs: 7207 Black • Glides: plastic to match legs 	<ol style="list-style-type: none"> 1 Style number 2 Fabric color number for upholstery, if selected 3 Wood color number for back and seat and/or arms, if selected 4 Options, if selected (see below) <p>▶ See <i>Surface Materials</i>, page 136.</p>

	Options	U.S. Price	Required to Specify
Surface Materials	Upholstery		
	• Fabric price group 1	No cost	Specify fabric color number.
	• Fabric price group 2	+\$ 20	Specify fabric color number.
	• Fabric price group 3	+\$ 45	Specify fabric color number.
	• Fabric price group 4	+\$ 70	Specify fabric color number.
	• Fabric price group 5	+\$ 85	Specify fabric color number.
	• Fabric price group 6	+\$100	Specify fabric color number.
	• Fabric price group 7	+\$125	Specify fabric color number.
	• Fabric price group 8	+\$160	Specify fabric color number.
	• Fabric price group 9	+\$200	Specify fabric color number.
• Fabric price group 10	+\$260	Specify fabric color number.	
• Leather price group	+\$375	Specify leather color number.	
• Customer's Own Material (COM) or Customer's Own Leather (COL)	+\$ 15	▶ See <i>Surface Materials Reference Manual</i> .	
• Fire Code Seating (FCS) on applicable models	+\$ 80	Specify with <i>fire code seating</i> .	
• Soil-retardant treatment applied to upholstery fabric	+\$ 17	▶ Pages 142–145 Specify with <i>soil-retardant treatment</i> .	
	Back and seat and/or arms		
	• Customiz stain on wood	+\$ 24	Specify with <i>Customiz stain</i> . ▶ See <i>Surface Materials Reference Manual</i> .
	Legs		
	• Sterling	+\$ 25	Specify with <i>7098 Sterling legs</i> .
Ganging Device	• Removable ganging device to link adjacent chairs: black plastic only	+\$ 15	Add suffix G to the style number.



For Canadian Pricing
Multiply U.S. Price by 1.38.
▶ See page 1 for details.

Specification Information

Upholstered Back and Seat



• Style Number
• U.S. Base Price

Wood Back and Upholstered Seat



• Style Number
• U.S. Base Price

Wood Back and Seat



• Style Number
• U.S. Base Price

With Wood Arms

DECKC34 \$500

DECKC24 \$540

DECKC14 \$555

With Urethane Arms

DECKC35 \$475

DECKC25 \$515

DECKC15 \$530

Upholstered Back and Seat



• Style Number
• U.S. Base Price

Wood Back and Upholstered Seat



• Style Number
• U.S. Base Price

Wood Back and Seat



• Style Number
• U.S. Base Price

Without Arms

DECKA3 \$450

DECKA2 \$490

DECKA1 \$505



For Canadian Pricing
Multiply U.S. Price by 1.38.
▶ See page 1 for details.

Deck Tables

on Maple Substrate

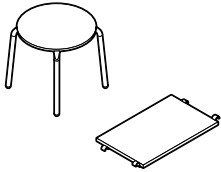

Standard Includes		Required to Specify
<ul style="list-style-type: none"> ▶ Need help? Product details, page 99 	<ul style="list-style-type: none"> • Table: maple veneer • 3/4"-thick top with maple edge banding • Three-ply construction: maple veneer stained to match selected finish • Legs on occasional table: 7207 Black 	<ul style="list-style-type: none"> 1 Style number 2 Wood color number 3 Options, if selected (see below) ▶ See <i>Surface Materials</i>, page 136.

Options	U.S. Price	Required to Specify
Surface Materials <ul style="list-style-type: none"> • Wood • Customiz stain on wood 	+\$24	Specify with <i>Customiz stain</i> . ▶ See <i>Surface Materials Reference Manual</i> .
<ul style="list-style-type: none"> • Legs • Sterling 	+\$25	Specify with <i>7098 Sterling legs</i> .

Specification Information

Occasional Table



Dimensions			Style Number	U.S. Base Price
D	W	H		
18"	18"	17"	DECKFT	\$385

In-Line Table



Dimensions			Style Number	U.S. Base Price
D	W	H		
15"	24"	16½"	DECKLT	\$200



For Canadian Pricing
 Multiply U.S. Price by 1.38.
 ▶ See page 1 for details.

Deck Tables

Species Specific

Deck Tables
Species Specific

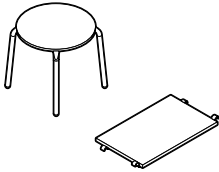

Standard Includes		Required to Specify
<ul style="list-style-type: none"> ▶ Need help? Product details, page 99 	<ul style="list-style-type: none"> • Table: wood • 3/4"-thick top with veneer edge banding • Three-ply construction • Legs on occasional table: 7207 Black 	<ul style="list-style-type: none"> 1 Style number 2 Wood color number 3 Options, if selected (see below) ▶ See <i>Surface Materials</i>, page 136.

Options	U.S. Price	Required to Specify
Surface Materials Wood <ul style="list-style-type: none"> • Customiz stain on wood 	+\$ 24	Specify with <i>Customiz stain</i> . ▶ See <i>Surface Materials Reference Manual</i> .
Legs <ul style="list-style-type: none"> • Sterling 	+\$ 25	Specify with <i>7098 Sterling legs</i> .

Specification Information

Occasional Table



Dimensions			Style Number	U.S. Base Price
D	W	H		
18"	18"	17"	DT1818	\$412

In-Line Table



Dimensions			Style Number	U.S. Base Price
D	W	H		
15"	24"	16 1/2"	DT2415	\$200

Stackable



For Canadian Pricing
Multiply U.S. Price by 1.38.
▶ See page 1 for details.

Deck Stools

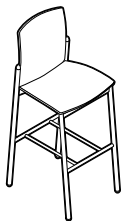

Standard Includes	Required to Specify
<ul style="list-style-type: none"> ▶ Need help? Product details, page 99 • Back and seat: fabric price group 1 or maple • Legs: 7207 Black metal • Glides: plastic to match legs 	<ol style="list-style-type: none"> 1 Style number 2 Fabric and/or wood color number for back and seat 3 Options, if selected (see below) <ul style="list-style-type: none"> ▶ See <i>Surface Materials</i>, page 136.

Options	U.S. Price	Required to Specify
Surface Materials	Upholstery	
	<ul style="list-style-type: none"> • Fabric price group 1: No cost • Fabric price group 2: +\$ 20 • Fabric price group 3: +\$ 45 • Fabric price group 4: +\$ 70 • Fabric price group 5: +\$ 85 • Fabric price group 6: +\$100 • Fabric price group 7: +\$125 • Fabric price group 8: +\$160 • Fabric price group 9: +\$200 • Fabric price group 10: +\$260 • Leather price group: +\$375 • Customer's Own Material (COM) or Customer's Own Leather (COL): +\$ 15 • Fire Code Seating (FCS) on applicable models: +\$ 80 • Soil-retardant treatment applied to upholstery fabric: +\$ 17 	<ul style="list-style-type: none"> Specify fabric color number. Specify fabric color number. Specify fabric color number. Specify fabric color number. Specify fabric color number. Specify fabric color number. Specify fabric color number. Specify fabric color number. Specify fabric color number. Specify leather color number. ▶ See <i>Surface Materials Reference Manual</i>. Specify with <i>fire code seating</i>. ▶ Pages 142–145 Specify with <i>soil-retardant treatment</i>.
	Back and seat	
	<ul style="list-style-type: none"> • Customiz stain on wood: +\$ 24 	<ul style="list-style-type: none"> Specify with <i>Customiz stain</i>. ▶ See <i>Surface Materials Reference Manual</i>.
	Legs	
	<ul style="list-style-type: none"> • Sterling: +\$ 25 	<ul style="list-style-type: none"> Specify with <i>7098 Sterling legs</i>.

Specification Information

Wood Back and Seat

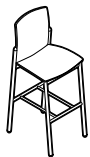

• **Style Number**
.....
.....

• **U.S. Base Price**
.....
.....

DECKS1 \$580

Wood Back and Upholstered Seat



• **Style Number**
.....
.....

• **U.S. Base Price**
.....
.....

DECKS2 \$565

Upholstered Back and Seat



• **Style Number**
.....
.....

• **U.S. Base Price**
.....
.....

DECKS3 \$525



For Canadian Pricing
Multiply U.S. Price by 1.38.
▶ See page 1 for details.

Lounge Seating

Community Lounge	106
Dearborn	110
Étude	114
Groove	118

Community Lounge

Community Lounge

offers a simple, versatile design featuring rectilinear lines.

Community Lounge seating

is fully upholstered.

Contemporary styling:

thin, simple contours

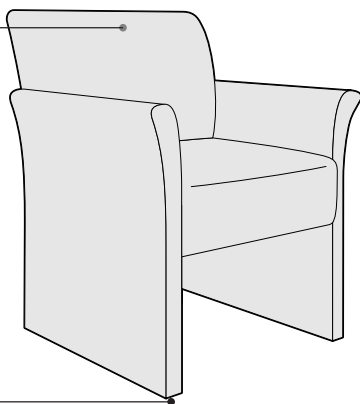

Glides are 1" in diameter.

Product Details

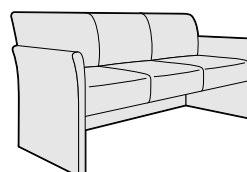
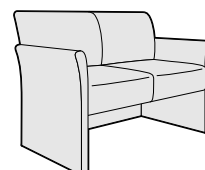
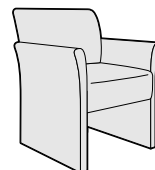

Community Lounge seating is made up of a club chair, settee, and sofa.

Actual Dimensions

	Club Chair	Settee	Sofa
Overall depth	28½"	28½"	28½"
Overall width	27"	50"	72"
Overall height	34"	34"	34"
Seat depth	21"	21"	21"
Seat width	20"	43"	65"
Back width	20"	43"	65"
Back height	15"	15"	15"
Width between arms	20"	43"	65"
Seat to floor height	19"	19"	19"
Arm height from floor	25½"	25½"	25½"

Surface Materials

Upholstery

- Vinyl
- Fabric
- Fabric with soil-retardant treatment (option)
- Leather

Tip: Minor comfort wrinkles are inherent in the design of the seat and cushions.

Glides

- Stainless steel only

All Steelcase seating with standard upholstery fabrics

complies with requirements of the BIFMA First Generation Voluntary Upholstered Furniture Flammability Standard, as well as the State of California Technical Bulletins 116 and 117. All standard seating is labeled to be in compliance with California TB116/117.

Programs & Services

▶ See the *Surface Materials Reference Manual* for further detail about programs and services offered for seating.

The Customer's Own Material (COM) Program

offers the opportunity for customers to select fabrics that are not offered through the standard Steelcase surface materials program for use on Steelcase products. Through the COM program, Steelcase will test your materials for application on Steelcase products. Once approved, you can place your order. Steelcase will facilitate the entire ordering process and give you a production schedule. Steelcase will order the COM fabric directly from the textile manufacturer. For up-to-date information regarding fabric test results for all COM fabrics and details regarding yardage requirements for most Seating lines, visit the COM Web site. To locate the COM Web site:

- Visit www.steelcase.com
- Click on "Knowledge & Design"
- Select "Customer's Own Material"

Soil retardants are treatments that provide long-term soil and stain resistance to a fabric without affecting the shade or the integrity of the fabric. The following Steelcase Textiles are available pre-treated with soil retardant. (You do not need to select the soil-retardant option for these fabrics and incur the \$17 upcharge.)

- Canzoné
- Cavalcade
- Jacks
- Link
- Regis
- Roulette
- Spyder
- Sweepstakes

Soil-retardant treatment is available on all other seating fabrics at an additional \$17 U.S. per seating unit. To order this option, please select "Soil-Retardant Treatment" under "Optional Accessories."

For soil-retardant treatment on COMs, please select "Soil-Retardant Treatment" under "Optional Accessories." Minimums or additional yardage may be required. Please contact the vendor directly for specific information.

Extended lead times may be necessary for this service.

Contact your Steelcase Sales Service representative at 1.888.STEELCASE (1.888.783.3522).

Fire Codes

▶ See pages 142–145 for upholstery fabrics available for use with FCS modification.

Steelcase offers Fire Code Seating modification (FCS) on nearly all seating models. The most rigorous fire codes in the nation have been developed in California, and the Steelcase FCS modification is designed to meet those codes. Fire Code Seating (FCS) indicates that a product is constructed to meet the strict fire code requirements of high public occupancy areas such as theaters, meeting rooms, and lobbies. The FCS standards will meet both the State of California Home Furnishing Technical Bulletin 133 (Cal TB 133) and Boston Fire Code (BFC). Boston adopted the California Home Furnishing Technical Bulletin TB 133 test standard in 1992.

Local codes may have special requirements for upholstery.

Resources

Community Lounge Brochure

Form number S2763

Community Lounge Seating

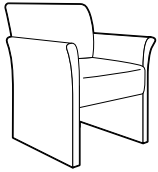

Standard Includes		Required to Specify
<ul style="list-style-type: none"> ▶ Need help? Product details, page 106 	<ul style="list-style-type: none"> • Upholstery: fabric price group 1 • 1"-diameter glides: stainless steel only 	<ol style="list-style-type: none"> 1 Style number 2 Fabric or leather color number for upholstery 3 Options, if selected (see below) <ul style="list-style-type: none"> ▶ See <i>Surface Materials</i>, page 136.

	Options	U.S. Price	Required to Specify
Surface Materials	Upholstery		
	• Fabric price group 1	No cost	Specify fabric color number.
	• Fabric price group 2	+\$ 80	Specify fabric color number.
	• Fabric price group 3	+\$ 264	Specify fabric color number.
	• Fabric price group 4	+\$ 328	Specify fabric color number.
	• Fabric price group 5	+\$ 400	Specify fabric color number.
	• Fabric price group 6	+\$ 576	Specify fabric color number.
	• Fabric price group 7	+\$ 680	Specify fabric color number.
	• Fabric price group 8	+\$1000	Specify fabric color number.
	• Fabric price group 9	+\$1280	Specify fabric color number.
	• Fabric price group 10	+\$1560	Specify fabric color number.
	• Club chair leather price group	+\$1100	Specify leather color number.
	• Settee leather price group	+\$1400	Specify leather color number.
• Sofa leather price group	+\$2100	Specify leather color number.	
• Customer's Own Material (COM) or Customer's Own Leather (COL)	+\$ 85	▶ See <i>Surface Materials Reference Manual</i> .	
• Fire Code Seating (FCS) on applicable models	+\$ 80	Specify <i>with fire code seating</i> .	
• Soil-retardant treatment applied to upholstery fabric	+\$ 17	▶ Pages 142–145 Specify <i>with soil-retardant treatment</i> .	



For Canadian Pricing
Multiply U.S. Price by 1.38.
▶ See page 1 for details.

Specification Information

Club Chair

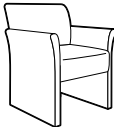

• **Style Number**
• **U.S. Base Price**

CCL1 \$ 803

Settee

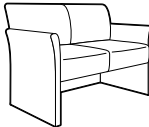

• **Style Number**
• **U.S. Base Price**

CCL2 \$1283

Sofa

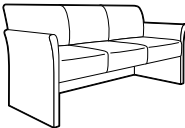

• **Style Number**
• **U.S. Base Price**

CCL3 \$1542



For Canadian Pricing
Multiply U.S. Price by 1.38.
▶ See page 1 for details.

Dearborn

Dearborn wing chair and camel-back sofa are ideal for traditional settings.

Traditional camel-back styling.

Upholstered in leather or fabric.

Scrolled arms.

Generous proportions for comfort.

Base is maple.

Glides are 1/2" diameter.

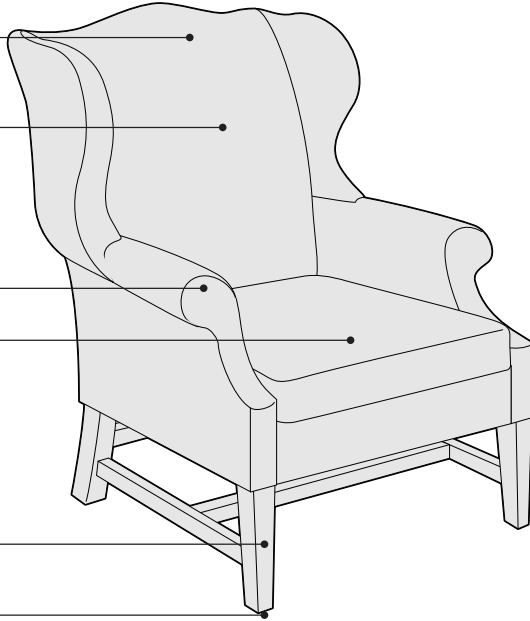

Surface Materials

Upholstery

- Vinyl
- Fabric
- Fabric with soil-retardant treatment (option)
- Leather

Tip: Minor comfort wrinkles are inherent in the design of the seat and cushions.

Base and legs

- Maple
- Tip: Wood finishes applied to maple will match the color of stains applied to oak, walnut, or cherry but will not show the same natural grain.*

- Customiz stain on wood (option)

Glides

- Stainless steel only

All Steelcase seating with standard upholstery fabrics complies with requirements of the BIFMA First Generation Voluntary Upholstered Furniture Standard, as well as State of California Technical Bulletins 116 and 117. All standard seating is labeled to be in compliance with California TB116/117.

Programs & Services

► See the *Surface Materials Reference Manual* for further detail about programs and services offered for seating.

The Customer's Own Material (COM) Program

offers the opportunity for customers to select fabrics that are not offered through the standard Steelcase surface materials program for use on Steelcase products. Through the COM program, Steelcase will test your materials for application on Steelcase products. Once approved, you can place your order. Steelcase will facilitate the entire ordering process and give you a production schedule. Steelcase will order the COM fabric directly from the textile manufacturer. For up-to-date information regarding fabric test results for all COM fabrics and details regarding yardage requirements for most Seating lines, visit the COM Web site. To locate the COM Web site:

- Visit www.steelcase.com
- Click on "Knowledge & Design"
- Select "Customer's Own Material"

Soil retardants are treatments that provide long-term soil and stain resistance to a fabric without affecting the shade or the integrity of the fabric. The following Steelcase Textiles are available pre-treated with soil retardant. (You do not need to select the soil-retardant option for these fabrics and incur the \$17 upcharge.)

- Canzoné
- Cavalcade
- Jacks
- Link
- Regis
- Roulette
- Spyder
- Sweepstakes

Soil-retardant treatment is available on all other seating fabrics at an additional \$17 U.S. per seating unit. To order this option, please select "Soil-Retardant Treatment" under "Optional Accessories."

For soil-retardant treatment on COMs, please select "Soil-Retardant Treatment" under "Optional Accessories." Minimums or additional yardage may be required. Please contact the vendor directly for specific information.

Extended lead times may be necessary for this service.

Contact your Steelcase Sales Service representative at 1.888.STEELCASE (1.888.783.3522).

Fire Codes

► See pages 142–145 for upholstery fabrics available for use with FCS modification.

Steelcase offers Fire Code Seating modification (FCS) on nearly all seating models. The most rigorous fire codes in the nation have been developed in California, and the Steelcase FCS modification is designed to meet those codes. Fire Code Seating (FCS) indicates that a product is constructed to meet the strict fire code requirements of high public occupancy areas such as theaters, meeting rooms, and lobbies. The FCS standards will meet both the State of California Home Furnishing Technical Bulletin 133 (Cal TB 133) and Boston Fire Code (BFC). Boston adopted the California Home Furnishing Technical Bulletin TB 133 test standard in 1992.

Local codes may have special requirements for upholstery.

Resources

Traditional Brochure
Form number S11196

Actual Dimensions

	Wing Chair	Camel-back Sofa
Overall depth	33"	34"
Overall width	34"	86"
Overall height	43"	36"
Seat depth	20"	20½"
Seat width	21"	70"
Back width	21"	70"
Back height	23"	16"
Width between arms	23"	70"
Seat to floor height	20"	20"
Arm height from floor	26"	26"

Dearborn Wingback Lounge Chair

Dearborn Wingback
Lounge Chair

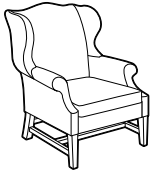

Standard Includes		Required to Specify
<ul style="list-style-type: none"> ▶ Need help? Product details, page 110 	<ul style="list-style-type: none"> • Base and legs: maple • Upholstery on seat: fabric price group 1 • Glides: stainless steel only 	<ol style="list-style-type: none"> 1 Style number 2 Fabric color number for upholstery 3 Wood color number for base and legs 4 Options, if selected (see below) <ul style="list-style-type: none"> ▶ See <i>Surface Materials</i>, page 136.

	Options	U.S. Price	Required to Specify
Surface Materials	Upholstery		
	• Fabric price group 1	No cost	Specify fabric color number.
	• Fabric price group 2	+\$ 80	Specify fabric color number.
	• Fabric price group 3	+\$ 264	Specify fabric color number.
	• Fabric price group 4	+\$ 328	Specify fabric color number.
	• Fabric price group 5	+\$ 400	Specify fabric color number.
	• Fabric price group 6	+\$ 576	Specify fabric color number.
	• Fabric price group 7	+\$ 680	Specify fabric color number.
	• Fabric price group 8	+\$1000	Specify fabric color number.
	• Fabric price group 9	+\$1280	Specify fabric color number.
• Fabric price group 10	+\$1560	Specify fabric color number.	
• Leather price group	+\$1110	Specify leather color number.	
• Customer's Own Material (COM) or Customer's Own Leather (COL)	+\$ 85	▶ See <i>Surface Materials Reference Manual</i> .	
• Fire Code Seating (FCS) on applicable models	+\$ 80	Specify with <i>fire code seating</i> . ▶ Pages 142–145	
• Soil-retardant treatment applied to upholstery fabric	+\$ 17	Specify with <i>soil-retardant treatment</i> .	
	Base and legs		
	• Customiz stain on wood	+\$ 24	Specify with <i>Customiz stain</i> . ▶ See <i>Surface Materials Reference Manual</i> .

Specification Information	
• Style Number	• U.S. Base Price
OD31	\$1496
.	.
.	.

Lounge



For Canadian Pricing
Multiply U.S. Price by 1.38.
▶ See page 1 for details.

Dearborn Camelback Sofa

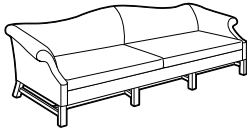

► Need help?
Product details,
page 110

Standard Includes

- Base and legs: maple
- Upholstery on seat: fabric price group 1
- Glides: stainless steel only

Required to Specify

- 1 Style number
 - 2 Fabric color number for upholstery
 - 3 Wood color number for base and legs
 - 4 Options, if selected (see below)
- See *Surface Materials*, page 136.

Options		U.S. Price	Required to Specify
Surface Materials	Upholstery		
	• Fabric price group 1	No cost	Specify fabric color number.
	• Fabric price group 2	+\$ 120	Specify fabric color number.
	• Fabric price group 3	+\$ 396	Specify fabric color number.
	• Fabric price group 4	+\$ 492	Specify fabric color number.
	• Fabric price group 5	+\$ 600	Specify fabric color number.
	• Fabric price group 6	+\$ 864	Specify fabric color number.
	• Fabric price group 7	+\$1020	Specify fabric color number.
	• Fabric price group 8	+\$1500	Specify fabric color number.
	• Fabric price group 9	+\$1920	Specify fabric color number.
	• Fabric price group 10	+\$2340	Specify fabric color number.
	• Leather price group	+\$2100	Specify leather color number.
	• Customer's Own Material (COM) or Customer's Own Leather (COL)	+\$ 125	► See <i>Surface Materials Reference Manual</i> .
• Fire Code Seating (FCS) on applicable models	+\$ 80	Specify with <i>fire code seating</i> . ► Pages 142–145	
• Soil-retardant treatment applied to upholstery fabric	+\$ 17	Specify with <i>soil-retardant treatment</i> .	
Base and legs			
• Customiz stain on wood	+\$ 24	Specify with <i>Customiz stain</i> . ► See <i>Surface Materials Reference Manual</i> .	

Specification Information

• Style Number	• U.S. Base Price
OD41	\$2846



For Canadian Pricing
Multiply U.S. Price by 1.38.
► See page 1 for details.



For Canadian Pricing
Multiply U.S. Price by 1.38.
▶ See page 1 for details.

Étude

Étude lounge seating includes a club chair, love seat, and sofa in transitional styling. The wood base and curved legs compliment both transitional and contemporary environments.

Simple, curved transitional styling.

Arms follow a graceful curve.

Casual folds and gathers in back are designed to create a hand-crafted look.

Generous, comfortable proportions.

Base is maple.

Glides are 1/2" diameter.

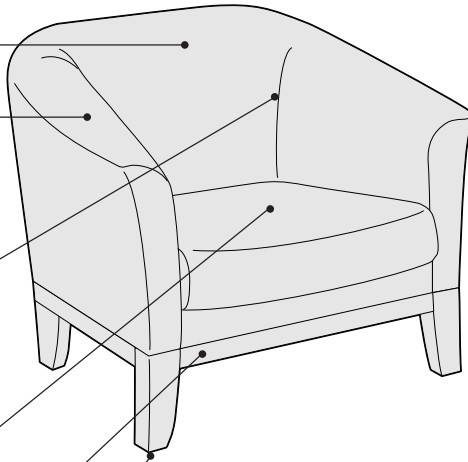

Surface Materials

Upholstery

- Fabric
- Fabric with soil-retardant treatment (option)
- Vinyl
- Leather

Tip: Minor comfort wrinkles are inherent in the design of the seat and cushions.

Base and legs

- Maple
- Tip: Wood finishes applied to maple will match the color of stains applied to oak, walnut, or cherry but will not show the same natural grain.*
- Customiz stain (option)

Glides

- Stainless steel only

All Steelcase seating with standard upholstery fabrics complies with requirements of the BIFMA First Generation Voluntary Upholstered Furniture Standard, as well as State of California Technical Bulletins 116 and 117. All standard seating is labeled to be in compliance with California TB116/117.

Programs & Services

► See the *Surface Materials Reference Manual* for further detail about programs and services offered for seating.

The Customer's Own Material (COM) Program offers the opportunity for customers to select fabrics that are not offered through the standard Steelcase surface materials program for use on Steelcase products. Through the COM program, Steelcase will test your materials for application on Steelcase products. Once approved, you can place your order. Steelcase will facilitate the entire ordering process and give you a production schedule. Steelcase will order the COM fabric directly from the textile manufacturer. For up-to-date information regarding fabric test results for all COM fabrics and details regarding yardage requirements for most Seating lines, visit the COM Web site. To locate the COM Web site:

- Visit www.steelcase.com
- Click on "Knowledge & Design"
- Select "Customer's Own Material"

Soil retardants are treatments that provide long-term soil and stain resistance to a fabric without affecting the shade or the integrity of the fabric. The following Steelcase Textiles are available pre-treated with soil retardant. (You do not need to select the soil-retardant option for these fabrics and incur the \$17 upcharge.)

- Canzoné
- Cavalcade
- Jacks
- Link
- Regis
- Roulette
- Spyder
- Sweepstakes

Actual Dimensions

	Chair	Love Seat	Sofa
Overall depth	30"	30"	30"
Overall width	32"	56"	72"
Overall height	31"	31"	31"
Seat depth	22"	22"	22"
Seat width	17"	41"	57"
Back width	15"	39"	55"
Back height	16"	16"	16"
Width between arms	21"	45"	61"
Seat to floor height	17"	17"	17"
Arm height from floor	26"	26"	26"

Soil-retardant treatment is available on all other seating fabrics at an additional \$17 U.S. per seating unit. To order this option, please select "Soil-Retardant Treatment" under "Optional Accessories."

For soil-retardant treatment on COMs, please select "Soil-Retardant Treatment" under "Optional Accessories." Minimums or additional yardage may be required. Please contact the vendor directly for specific information.

Extended lead times may be necessary for this service.

Contact your Steelcase Sales Service representative at 1.888.STEELCASE (1.888.783.3522).

Fire Codes

▶ See pages 142–145 for upholstery fabrics available for use with FCS modification.

Steelcase offers Fire Code Seating modification (FCS) on nearly all seating models. The most rigorous fire codes in the nation have been developed in California, and the Steelcase FCS modification is designed to meet those codes. Fire Code Seating (FCS) indicates that a product is constructed to meet the strict fire code requirements of high public occupancy areas such as theaters, meeting rooms, and lobbies. The FCS standards will meet both the State of California Home Furnishing Technical Bulletin 133 (Cal TB 133) and Boston Fire Code (BFC). Boston adopted the California Home Furnishing Technical Bulletin TB 133 test standard in 1992.

Fire code approval:

Étude club chair 0811 is available in the following fabrics only:
Leather
Vinyl

Local codes may have special requirements for upholstery.

Resources

Étude Brochure

Form number S11072

Étude Club Chair

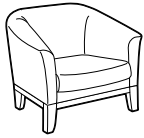

Standard Includes		Required to Specify
<ul style="list-style-type: none"> ▶ Need help? Product details, page 114 	<ul style="list-style-type: none"> • Base and legs: maple • Upholstery: fabric price group 1 • Glides: stainless steel only 	<ol style="list-style-type: none"> 1 Style number 2 Fabric color number for upholstery 3 Wood color number for base and legs 4 Options, if selected (see below) <ul style="list-style-type: none"> ▶ See <i>Surface Materials</i>, page 136.

Options	U.S. Price	Required to Specify
Surface Materials Upholstery <ul style="list-style-type: none"> • Fabric price group 1 • Fabric price group 2 • Fabric price group 3 • Fabric price group 4 • Fabric price group 5 • Fabric price group 6 • Fabric price group 7 • Fabric price group 8 • Fabric price group 9 • Fabric price group 10 • Leather price group • Customer's Own Material (COM) or Customer's Own Leather (COL) • Fire Code Seating (FCS) on applicable models • Soil-retardant treatment applied to upholstery fabric 	No cost +\$ 40 +\$132 +\$164 +\$225 +\$288 +\$340 +\$500 +\$640 +\$780 +\$835 +\$ 55 +\$ 80 +\$ 17	Specify fabric color number. Specify fabric color number. Specify fabric color number. Specify fabric color number. Specify fabric color number. Specify fabric color number. Specify fabric color number. Specify fabric color number. Specify fabric color number. Specify fabric color number. Specify leather color number. ▶ See <i>Surface Materials Reference Manual</i> . Specify with <i>fire code seating</i> . ▶ Pages 142–145 Specify with <i>soil-retardant treatment</i> .
Base and legs <ul style="list-style-type: none"> • Customiz stain on wood 	+\$ 24	Specify with <i>Customiz stain</i> . ▶ See <i>Surface Materials Reference Manual</i> .

Specification Information

Club Chair

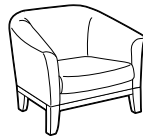

Style Number	U.S. Base Price
0811	\$2031



For Canadian Pricing
 Multiply U.S. Price by 1.38.
 ▶ See page 1 for details.

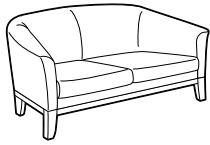

Standard Includes		Required to Specify
<ul style="list-style-type: none"> ▶ Need help? Product details, page 114 	<ul style="list-style-type: none"> • Base and legs: maple • Upholstery: fabric price group 1 • Glides: stainless steel only 	<ol style="list-style-type: none"> 1 Style number 2 Fabric color number for upholstery 3 Wood color number for base and legs 4 Options, if selected (see below) <ul style="list-style-type: none"> ▶ See <i>Surface Materials</i>, page 136.

Options	U.S. Price	Required to Specify
Surface Materials <ul style="list-style-type: none"> • Fabric price group 1 • Fabric price group 2 • Fabric price group 3 • Fabric price group 4 • Fabric price group 5 • Fabric price group 6 • Fabric price group 7 • Fabric price group 8 • Fabric price group 9 • Fabric price group 10 • Leather price group for love seat • Leather price group for sofa • Customer's Own Material (COM) or Customer's Own Leather (COL) for love seat • Customer's Own Material (COM) or Customer's Own Leather (COL) for sofa • Fire Code Seating (FCS) on applicable models • Soil-retardant treatment applied to upholstery fabric 	<ul style="list-style-type: none"> No cost +\$ 80 +\$ 264 +\$ 328 +\$ 400 +\$ 576 +\$ 680 +\$1000 +\$1280 +\$1560 +\$1100 +\$1400 +\$ 55 +\$ 85 +\$ 80 +\$ 17 	<ul style="list-style-type: none"> Specify fabric color number. Specify fabric color number. Specify fabric color number. Specify fabric color number. Specify fabric color number. Specify fabric color number. Specify fabric color number. Specify fabric color number. Specify fabric color number. Specify fabric color number. Specify leather color number. <ul style="list-style-type: none"> ▶ See <i>Surface Materials Reference Manual</i>. ▶ See <i>Surface Materials Reference Manual</i>. <ul style="list-style-type: none"> Specify with fire code seating. ▶ Pages 142–145 Specify with soil-retardant treatment.
Base and legs <ul style="list-style-type: none"> • Customiz stain on wood 	<ul style="list-style-type: none"> +\$ 24 	<ul style="list-style-type: none"> Specify with Customiz stain. ▶ See <i>Surface Materials Reference Manual</i>.

Specification Information			
Love Seat		Sofa	
• Style Number	• U.S. Base Price	• Style Number	• U.S. Base Price
0812	\$2822	0813	\$3469

Lounge



For Canadian Pricing
 Multiply U.S. Price by 1.38.
 ▶ See page 1 for details.

Groove

Groove modular lounge seating offers functional and aesthetic variety, access to power and data, and can reconfigure at a moment's notice.

Seat cushion is fully upholstered.

Legs or casters are available.

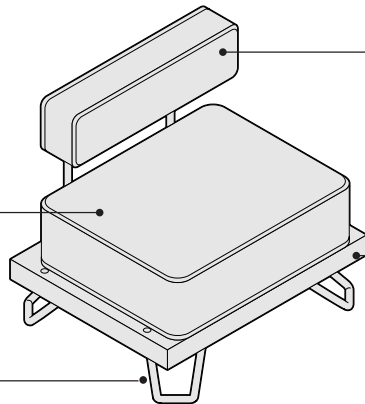

Upholstered block back

Wood base with or without grommets.

Plastic sail back with pillow.

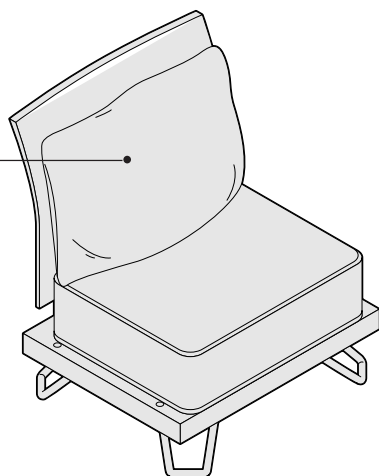

Product Details

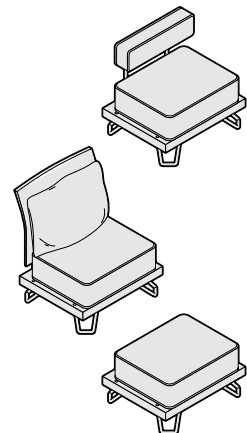

Groove lounge seating is available in two back styles—block back and sail back. Ottoman is also available. Chair and ottoman components are shipped separately and assembled in the field. Chairs can also be built up and reconfigured in the field. For build ups, order components separately.

Actual Dimensions

	Sail Back Chair	Block Back Chair	Ottoman
Overall depth	25 ¹ / ₄ "	25 ¹ / ₄ "	25 ¹ / ₄ "
Overall width	32 ¹ / ₄ "	32 ¹ / ₄ "	32 ¹ / ₄ "
Overall height	33 ¹ / ₄ "	28 ⁵ / ₈ "	15 ³ / ₄ "
Seat depth	18"	18 ¹ / ₄ "	23"
Seat width	28 ³ / ₄ "	28 ³ / ₄ "	28 ³ / ₄ "
Back width	30"	26"	N.A.
Back height from seat	17 ¹ / ₂ "	12 ⁷ / ₈ "	N.A.
Seat to floor height	15 ³ / ₄ "	15 ³ / ₄ "	15 ³ / ₄ "

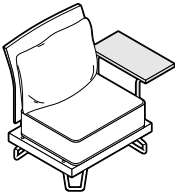

Sail back with tablet arm

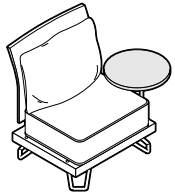

Sail back with round arm

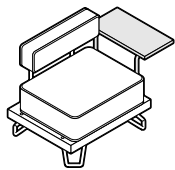

Block back with tablet arm

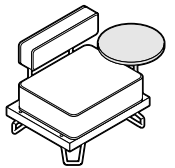

Block back with round arm

Round or tablet arm, ordered separately and field-installed, can be attached to left- or right-side of chairs.

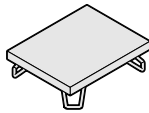

Table without grommets

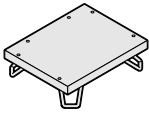

Table with grommets

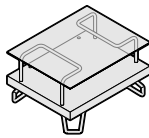

Table with acrylic top

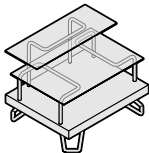

Table with acrylic top and shelf

Groove tables are available in a variety of configurations. Table components are shipped separately and assembled in the field. Tables can also be built up and reconfigured in the field. For build ups, order components separately.

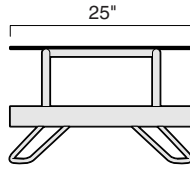

Table with acrylic top comes standard with larger acrylic piece.

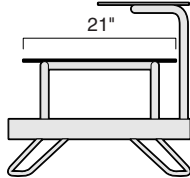

Table with acrylic top and shelf comes standard with smaller acrylic piece. Smaller acrylic top must be specified when ordering shelf kit. To create a buildup, you must order a smaller acrylic top with shelf kit.

Acrylic top sits on clear glides for tabletop applications. For shelf applications, acrylic is permanently affixed with clear screws.

Acrylic can be installed glossy side up or matte side up.

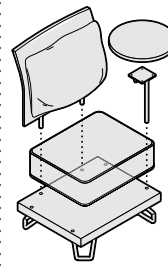
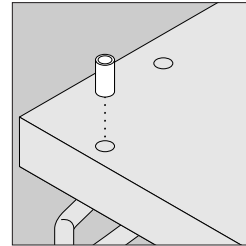
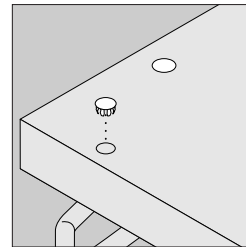

Table with grommets must be ordered to create buildups using table top, shelf, chair backs, and arm kits. *Tip: Grommets cannot be used to route cords or cables.*



Grommet sleeves provide stability for components and must be in place to properly install components.



Caps, standard with table with grommets, are used to cover the grommet holes when not in use. Underside of table has storage place to hold caps when not in use.

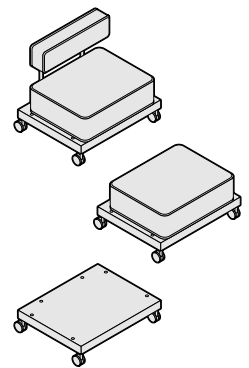

Caster version of chairs, tables, and ottoman enable easy product configurations and mobility.

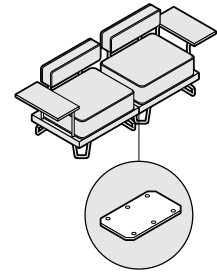

Ganging bracket is available to link chairs in the field for permanent connection.

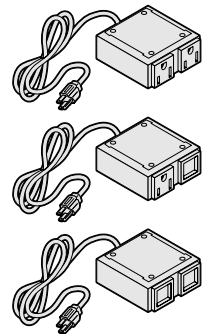

Power/data boxes are available to provide additional electrical outlets and voice and data receptacles where needed. Power/power, power/data, and data/data versions are available. Boxes are field-installed and can be mounted to the underside of base anywhere access to power and data is needed.

Surface Materials

Upholstery

- Fabric
- Fabric with soil-retardant treatment (option)
- Leather
- Vinyl

Legs and hardware

- 9201 Polished Chrome only

Base

- Wood finishes on veneer: open pore only
- Customiz stain (option)

Arms

- Wood finishes on veneer: open pore only
- Customiz stain (option)

Support tubes on arms:

- 9201 Polished Chrome only

Sail back

- 7032 Sandbar plastic only

Tables

- Wood finishes on veneer: open pore only
- Customiz stain (option)

Top and shelf

- Acrylic only (glossy on one side, matte on second side)

Casters

- Black plastic

Programs & Services

▶ See the *Surface Materials Reference Manual* for further detail about programs and services offered for seating.

The Customer's Own Material (COM) Program

offers the opportunity for customers to select fabrics that are not offered through the standard Steelcase surface materials program for use on Steelcase products. Through the COM program, Steelcase will test your materials for application on Steelcase products. Once approved, you can place your order. Steelcase will facilitate the entire ordering process and give you a production schedule. Steelcase will order the COM fabric directly from the textile manufacturer. For up-to-date information regarding fabric test results for all COM fabrics and details regarding yardage requirements for most Seating lines, visit the COM Web site. To locate the COM Web site:

- Visit www.steelcase.com
- Click on "Knowledge & Design"
- Select "Customer's Own Material"

Soil retardants are treatments that provide long-term soil and stain resistance to a fabric without affecting the shade or the integrity of the fabric. The following Steelcase Textiles are available pre-treated with soil retardant. (You do not need to select the soil-retardant option for these fabrics and incur the \$17 upcharge.)

- Canzoné
- Cavalcade
- Jacks
- Link
- Regis
- Roulette
- Spyder
- Sweepstakes

Soil-retardant treatment is available on all other seating fabrics at an additional \$17 U.S. per seating unit. To order this option, please select "Soil-Retardant Treatment" under "Optional Accessories."

For soil-retardant treatment on COMs, please select "Soil-Retardant Treatment" under "Optional Accessories." Minimums or additional yardage may be required. Please contact the vendor directly for specific information.

Extended lead times may be necessary for this service.

Contact your Steelcase Sales Service representative at 1.888.STEELCASE (1.888.783.3522).

Fire Codes

▶ See pages 142–145 for upholstery fabrics available for use with FCS modification.

Steelcase offers Fire Code Seating modification (FCS) on nearly all seating models. The most rigorous fire codes in the nation have been developed in California, and the Steelcase FCS modification is designed to meet those codes. Fire Code Seating (FCS) indicates that a product is constructed to meet the strict fire code requirements of high public occupancy areas such as theaters, meeting rooms, and lobbies. The FCS standards will meet both the State of California Home Furnishing Technical Bulletin 133 (Cal TB 133) and Boston Fire Code (BFC). Boston adopted the California Home Furnishing Technical Bulletin TB 133 test standard in 1992.

Local codes may have special requirements for upholstery.

Resources

Groove Brochure

Form number S11544



For Canadian Pricing
Multiply U.S. Price by 1.38.
▶ See page 1 for details.

Groove Chairs with Block Back

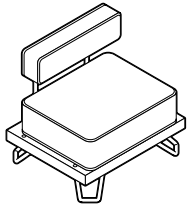

Standard Includes		Required to Specify
<ul style="list-style-type: none"> ▶ Need help? Product details, page 118 	<ul style="list-style-type: none"> • Base: wood veneer • Seat cushion and padded block back upholstery: fabric price group 1 • Legs, if selected: 9201 Polished Chrome only • Casters, if selected: black plastic only 	<ol style="list-style-type: none"> 1 Style number 2 Wood color number for base 3 Fabric color number for cushion and back 4 Options, if selected (see below) <ul style="list-style-type: none"> ▶ See <i>Surface Materials</i>, page 136.

Options	U.S. Price	Required to Specify
Surface Materials		
Upholstery <ul style="list-style-type: none"> • Fabric price group 1 • Fabric price group 2 • Fabric price group 3 • Fabric price group 4 • Fabric price group 5 • Fabric price group 6 • Fabric price group 7 • Fabric price group 8 • Fabric price group 9 • Fabric price group 10 • Leather price group • Customer's Own Material (COM) or Customer's Own Leather (COL) • Fire Code Seating (FCS) on applicable models • Soil-retardant treatment applied to upholstery fabric 	No cost +\$ 30 +\$ 99 +\$123 +\$170 +\$216 +\$255 +\$375 +\$480 +\$585 +\$835 +\$ 45 +\$ 80 +\$ 17	Specify fabric color number. Specify fabric color number. Specify fabric color number. Specify fabric color number. Specify fabric color number. Specify fabric color number. Specify fabric color number. Specify fabric color number. Specify fabric color number. Specify fabric color number. Specify leather color number. ▶ See <i>Surface Materials Reference Manual</i> . Specify with fire code seating. ▶ Pages 142–145 Specify with soil-retardant treatment.
Base <ul style="list-style-type: none"> • Customiz stain on wood 	+\$ 24	Specify with Customiz stain. ▶ See <i>Surface Materials Reference Manual</i> .

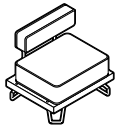
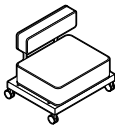
Specification Information			
Chair with Block Back and Legs		Chair with Block Back and Casters	
			
• Style Number	• U.S. Base Price	• Style Number	• U.S. Base Price
GVCHBL	\$1140	GVCHBLM	\$1140



For Canadian Pricing
 Multiply U.S. Price by 1.38.
 ▶ See page 1 for details.

Groove Chairs with Sail Back

Groove Chairs
with Sail Back

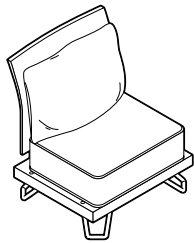

Standard Includes		Required to Specify
<ul style="list-style-type: none"> ▶ Need help? Product details, page 118 	<ul style="list-style-type: none"> • Base: wood veneer • Back: 7032 Sandbar plastic only • Seat cushion and back pillow upholstery: fabric price group 1 • Legs, if selected: 9201 Polished Chrome only • Casters, if selected: black plastic only 	<ol style="list-style-type: none"> 1 Style number 2 Wood color number for base 3 Fabric color number for cushion and pillow 4 Options, if selected (see below) <ul style="list-style-type: none"> ▶ See <i>Surface Materials</i>, page 136.

Options	U.S. Price	Required to Specify
Surface Materials	Upholstery	
<ul style="list-style-type: none"> • Fabric price group 1 • Fabric price group 2 • Fabric price group 3 • Fabric price group 4 • Fabric price group 5 • Fabric price group 6 • Fabric price group 7 • Fabric price group 8 • Fabric price group 9 • Fabric price group 10 • Leather price group • Customer's Own Material (COM) or Customer's Own Leather (COL) • Fire Code Seating (FCS) on applicable models • Soil-retardant treatment applied to upholstery fabric 	<ul style="list-style-type: none"> No cost +\$ 30 +\$ 99 +\$123 +\$170 +\$216 +\$255 +\$375 +\$480 +\$585 +\$835 +\$ 45 +\$ 80 +\$ 17 	<ul style="list-style-type: none"> Specify fabric color number. Specify fabric color number. Specify fabric color number. Specify fabric color number. Specify fabric color number. Specify fabric color number. Specify fabric color number. Specify fabric color number. Specify fabric color number. Specify fabric color number. Specify leather color number. ▶ See <i>Surface Materials Reference Manual</i>. Specify with fire code seating. ▶ Pages 142–145 Specify with soil-retardant treatment.
Base	<ul style="list-style-type: none"> • Customiz stain on wood 	<ul style="list-style-type: none"> +\$ 24 Specify with Customiz stain. ▶ See <i>Surface Materials Reference Manual</i>.

Specification Information

Chair with Sail Back and Legs



Style Number	U.S. Base Price
GVCHSL	\$1350

Chair with Sail Back and Casters



Style Number	U.S. Base Price
GVCHSLM	\$1350

Lounge



For Canadian Pricing
Multiply U.S. Price by 1.38.
▶ See page 1 for details.

Groove Ottomans

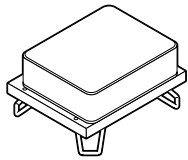

Standard Includes	Required to Specify
<ul style="list-style-type: none"> ▶ Need help? Product details, page 118 • Base: wood veneer • Seat cushion upholstery: fabric price group 1 • Legs, if selected: 9201 Polished Chrome only • Casters, if selected: black plastic only 	<ol style="list-style-type: none"> 1 Style number 2 Wood color number for base 3 Fabric color number for cushion 4 Options, if selected (see below) <ul style="list-style-type: none"> ▶ See <i>Surface Materials</i>, page 136.

Options	U.S. Price	Required to Specify
Surface Materials	Upholstery <ul style="list-style-type: none"> • Fabric price group 1: No cost • Fabric price group 2: +\$ 20 • Fabric price group 3: +\$ 45 • Fabric price group 4: +\$ 70 • Fabric price group 5: +\$100 • Fabric price group 6: +\$144 • Fabric price group 7: +\$170 • Fabric price group 8: +\$250 • Fabric price group 9: +\$320 • Fabric price group 10: +\$390 • Leather price group: +\$375 • Customer's Own Material (COM) or Customer's Own Leather (COL): +\$ 26 • Fire Code Seating (FCS) on applicable models: +\$ 80 • Soil-retardant treatment applied to upholstery fabric: +\$ 17 	<ul style="list-style-type: none"> Specify fabric color number. Specify fabric color number. Specify fabric color number. Specify fabric color number. Specify fabric color number. Specify fabric color number. Specify fabric color number. Specify fabric color number. Specify fabric color number. Specify fabric color number. Specify leather color number. ▶ See <i>Surface Materials Reference Manual</i>. Specify with fire code seating. ▶ Pages 142–145 Specify with soil-retardant treatment.
Base <ul style="list-style-type: none"> • Customiz stain on wood: +\$ 24 		<ul style="list-style-type: none"> Specify with Customiz stain. ▶ See <i>Surface Materials Reference Manual</i>.

Specification Information			
Ottoman with Legs		Ottoman with Casters	
• Style Number	• U.S. Base Price	• Style Number	• U.S. Base Price
GVOTT	\$840	GVOTTM	\$840

For Canadian Pricing
 Multiply U.S. Price by 1.38.
 ▶ See page 1 for details.



For Canadian Pricing
Multiply U.S. Price by 1.38.
▶ See page 1 for details.

Groove Tables

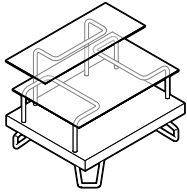

▶ Need help?
Product details,
page 119

Standard Includes

- Base: wood veneer
- Table top, if selected: clear acrylic
- Table top and shelf, if selected: clear acrylic
- Table top support tubes: 9201 Polished Chrome only
- Grommets sleeves, if table with grommets selected: 9201 Polished Chrome only
- Grommet caps, if table with grommets selected: 9201 Polished Chrome only
- Legs, if selected: 9201 Polished Chrome only
- Casters, if selected: black plastic only

Required to Specify

- 1 Style number
 - 2 Wood color number for base
 - 3 Options, if selected (see below)
- ▶ See *Surface Materials*, page 136.

	Options	U.S. Price	Required to Specify
Base	• Customiz stain on wood	+\$24	Specify with <i>Customiz stain</i> . ▶ See <i>Surface Materials Reference Manual</i> .

Specification Information

Table with Legs

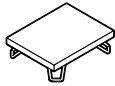

• Dimensions D W H	• Style Number	• U.S. Base Price
25¼" 32¼" 7¾"	GVTBL	\$540
:	:	:

Table with Casters

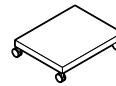

• Dimensions D W H	• Style Number	• U.S. Base Price
25¼" 32¼" 7¾"	GVTBLM	\$540
:	:	:

Table with Grommets and Legs

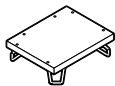

• Dimensions D W H	• Style Number	• U.S. Base Price
25¼" 32¼" 7¾"	GVTBLGR	\$630
:	:	:

Table with Grommets and Casters

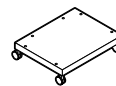

• Dimensions D W H	• Style Number	• U.S. Base Price
25¼" 32¼" 7¾"	GVTBLGRM	\$630
:	:	:

Tip: Table with grommets is used as a base to create chair, ottoman, and table buildups.



For Canadian Pricing
Multiply U.S. Price by 1.38.
▶ See page 1 for details.

Specification Information

Table with Top and Legs

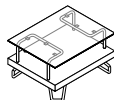

• Dimensions			• Style Number	• U.S. Base Price
D	W	H		
25¼"	32¼"	15⅛"	GVTBLTOP	\$1170

Table with Top and Casters

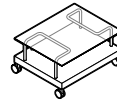

• Dimensions			• Style Number	• U.S. Base Price
D	W	H		
25¼"	32¼"	15⅛"	GVTBLTOPM	\$1170

Table with Top, Shelf, and Legs

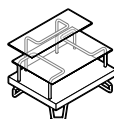

• Dimensions			• Style Number	• U.S. Base Price
D	W	H		
25¼"	32¼"	21⅞"	GVTBSHF	\$1500

Table with Top, Shelf, and Casters

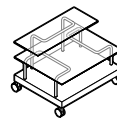

• Dimensions			• Style Number	• U.S. Base Price
D	W	H		
25¼"	32¼"	21⅞"	GVTBSHFM	\$1500



For Canadian Pricing
 Multiply U.S. Price by 1.38.
 ▶ See page 1 for details.

Additional Groove Components



Arm Kits



Tip: Height is measured from the floor.

Standard Includes		Required to Specify	
<ul style="list-style-type: none"> ▶ Need help? Product details, page 119 	<ul style="list-style-type: none"> • Round or tablet arm: wood veneer • Arm support: 9201 Polished Chrome only 	<ul style="list-style-type: none"> 1 Style number 2 Wood color number for arm 3 Options, if selected (see below) 	<ul style="list-style-type: none"> ▶ See <i>Surface Materials</i>, page 136.
Options		Required to Specify	
Base <ul style="list-style-type: none"> • Customiz stain on wood 	U.S. Price +\$24	<ul style="list-style-type: none"> Specify with <i>Customiz stain</i>. 	<ul style="list-style-type: none"> ▶ See <i>Surface Materials Reference Manual</i>.

Specification Information

Round Arm Kit				Tablet Arm Kit					
									
Dimensions			Style Number	U.S. Base Price	Dimensions			Style Number	U.S. Base Price
D	W	H			D	W	H		
13½"	13½"	23½"	GVARM	\$342	22½"	11½"	20⅝"	GVTABLET	\$342



For Canadian Pricing
Multiply U.S. Price by 1.38.
▶ See page 1 for details.

Back Kits

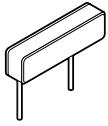

Standard Includes	Required to Specify
<ul style="list-style-type: none"> ▶ Need help? Product details, page 118 • Sail back, if selected: 7032 Sandbar plastic only • Padded block back upholstery, if selected: fabric price group 1 • Back support: 9201 Polished Chrome only 	<ul style="list-style-type: none"> 1 Style number 2 Fabric color number for back, if selected 3 Options, if selected (see below) ▶ See <i>Surface Materials</i>, page 136.

Options	U.S. Price	Required to Specify
Surface Materials <ul style="list-style-type: none"> • Fabric price group 1 • Fabric price group 2 • Fabric price group 3 • Fabric price group 4 • Fabric price group 5 • Fabric price group 6 • Fabric price group 7 • Fabric price group 8 • Fabric price group 9 • Fabric price group 10 • Leather price group • Customer's Own Material (COM) or Customer's Own Leather (COL) 	Upholstery for block back kit <ul style="list-style-type: none"> No cost +\$ 20 +\$ 45 +\$ 70 +\$ 85 +\$100 +\$125 +\$160 +\$200 +\$260 +\$200 +\$ 15 +\$ 80 +\$ 17 	<ul style="list-style-type: none"> Specify fabric color number. Specify fabric color number. Specify fabric color number. Specify fabric color number. Specify fabric color number. Specify fabric color number. Specify fabric color number. Specify fabric color number. Specify fabric color number. Specify leather color number. ▶ See <i>Surface Materials Reference Manual</i>. Specify with fire code seating. ▶ Pages 142–145 Specify with soil-retardant treatment.

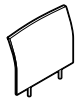
Specification Information			
Block Back Kit		Sail Back Kit	
			
• Style Number	• U.S. Base Price	• Style Number	• U.S. Base Price
GVBLKIT	\$300	GVSLKIT	\$420

Lounge

 **For Canadian Pricing**
 Multiply U.S. Price by 1.38.
 ▶ See page 1 for details.

Pillow for Use with Sail Back



Standard Includes	Required to Specify
<ul style="list-style-type: none"> ▶ Need help? Product details, page 118 • Back pillow upholstery: fabric price group 1 	<ul style="list-style-type: none"> 1 Style number 2 Fabric color number for pillow 3 Options, if selected (see below) ▶ See <i>Surface Materials</i>, page 136.

Options		U.S. Price	Required to Specify
Surface Materials	Upholstery		
	• Fabric price group 1	No cost	Specify fabric color number.
	• Fabric price group 2	+\$ 20	Specify fabric color number.
	• Fabric price group 3	+\$ 45	Specify fabric color number.
	• Fabric price group 4	+\$ 70	Specify fabric color number.
	• Fabric price group 5	+\$ 85	Specify fabric color number.
	• Fabric price group 6	+\$100	Specify fabric color number.
	• Fabric price group 7	+\$125	Specify fabric color number.
	• Fabric price group 8	+\$160	Specify fabric color number.
	• Fabric price group 9	+\$200	Specify fabric color number.
	• Fabric price group 10	+\$260	Specify fabric color number.
	• Leather price group	+\$200	Specify leather color number.
	• Customer's Own Material (COM) or Customer's Own Leather (COL)	+\$ 15	▶ See <i>Surface Materials Reference Manual</i> .
	• Fire Code Seating (FCS) on applicable models	+\$ 80	Specify with <i>fire code seating</i> .
	• Soil-retardant treatment applied to upholstery fabric	+\$ 17	▶ Pages 142–145 Specify with <i>soil-retardant treatment</i> .

Specification Information

Style Number	U.S. Base Price
GVPLW	\$90
.	.

For Canadian Pricing
 Multiply U.S. Price by 1.38.
 ▶ See page 1 for details.

Cushion

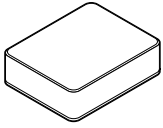

Standard Includes	Required to Specify
<ul style="list-style-type: none"> ▶ Need help? Product details, page 118 • Seat cushion upholstery: fabric price group 1 	<ul style="list-style-type: none"> 1 Style number 2 Fabric color number for back 3 Options, if selected (see below) ▶ See <i>Surface Materials</i>, page 136.

Options		U.S. Price	Required to Specify
Surface Materials	Upholstery		
	<ul style="list-style-type: none"> • Fabric price group 1 • Fabric price group 2 • Fabric price group 3 • Fabric price group 4 • Fabric price group 5 • Fabric price group 6 • Fabric price group 7 • Fabric price group 8 • Fabric price group 9 • Fabric price group 10 • Leather price group • Customer's Own Material (COM) or Customer's Own Leather (COL) • Fire Code Seating (FCS) on applicable models • Soil-retardant treatment applied to upholstery fabric 	<ul style="list-style-type: none"> No cost +\$ 20 +\$ 45 +\$ 70 +\$100 +\$144 +\$170 +\$250 +\$320 +\$390 +\$375 +\$ 26 +\$ 80 +\$ 17 	<ul style="list-style-type: none"> Specify fabric color number. Specify fabric color number. Specify fabric color number. Specify fabric color number. Specify fabric color number. Specify fabric color number. Specify fabric color number. Specify fabric color number. Specify fabric color number. Specify fabric color number. Specify leather color number. ▶ See <i>Surface Materials Reference Manual</i>. Specify with fire code seating. ▶ Pages 142–145 Specify with soil-retardant treatment.

Specification Information	
Style Number	U.S. Base Price
GVCUSH	\$210

Lounge

 **For Canadian Pricing**
 Multiply U.S. Price by 1.38.
 ▶ See page 1 for details.

Table Tops and Support Kit



Standard Includes		Required to Specify
<ul style="list-style-type: none"> ▶ Need help? Product details, page 119 	<ul style="list-style-type: none"> • Table top, if selected: clear acrylic • Table top support tubes, if selected: 9201 Polished Chrome only 	Style number

Specification Information

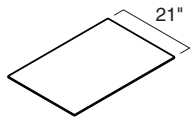
Dimensions		Style Number	U.S. Price
D	W		

Table Top for Use with Shelf

21"	32"	GVSMACR	\$390
:	:	:	:

Table Top for Use without Shelf

25"	32"	GVLGACR	\$450
:	:	:	:

Table Top Support Kit

		GVTBSUPP	\$120
:	:	:	:

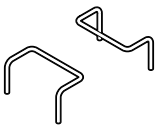
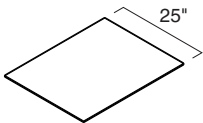
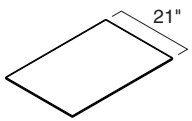

Shelf Kit

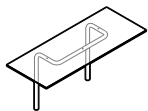

Standard Includes		Required to Specify
<ul style="list-style-type: none"> ▶ Need help? Product details, page 119 	<ul style="list-style-type: none"> • Shelf: clear acrylic • Shelf support: 9201 Polished Chrome only 	Style number

Specification Information

Style Number	U.S. Price
--------------	------------

GVSHLF	\$360
:	:



For Canadian Pricing
 Multiply U.S. Price by 1.38.
 ▶ See page 1 for details.

Legs

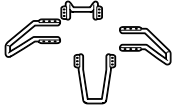

Standard Includes	Required to Specify
<ul style="list-style-type: none"> ▶ Need help? Product details, page 118 • Set of four legs: 9201 Polished Chrome only 	Style number

Specification Information	
Style Number	U.S. Price
GVLEG	\$240

Castors

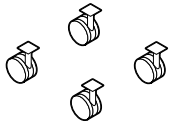

Standard Includes	Required to Specify
<ul style="list-style-type: none"> ▶ Need help? Product details, page 119 • Set of four locking casters: black plastic 	Style number

Specification Information	
Style Number	U.S. Price
GVCSTR	\$240



For Canadian Pricing
 Multiply U.S. Price by 1.38.
 ▶ See page 1 for details.

Power/Data Boxes

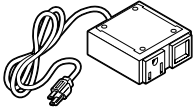

Tip: Power and data boxes should not be used with products with casters; casters and cords can become entangled.

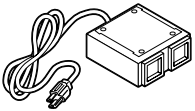
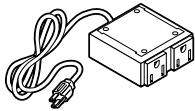
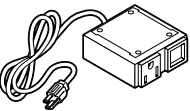

Standard Includes	Required to Specify
<ul style="list-style-type: none"> ▶ Need help? Product details, page 119 • Power/data box • Power/power box • Data/data box 	Style number

Specification Information

• Dimensions			• Style	• U.S.
D	W	H	Number	Price

Power/Data Box

3"	3"	1"	GVPDBOX	\$180
:	:	:	:	:

Power/Power Box

3"	3"	1"	GVPPOBOX	\$180
:	:	:	:	:

Data/Data Box

3"	3"	1"	GVDDBOX	\$180
:	:	:	:	:

Ganging Bracket



Standard Includes	Required to Specify
<ul style="list-style-type: none"> ▶ Need help? Product details, page 119 • Ganging bracket: metal 	Style number

Specification Information

• Style	• U.S.
Number	Price

GVRKT	\$12
:	:



For Canadian Pricing
 Multiply U.S. Price by 1.38.
 ▶ See page 1 for details.

Surface Materials

Surface Materials	136
Wood Seating Upholstery Matrix	140
Designtex Graded-In Wood Seating Upholstery Matrix	141
Fire Code Wood Seating Upholstery Matrix	142
Fire Code Wood Seating Upholstery Matrix for Designtex	143
Fire Code Seating (FCS) Exceptions for Wood Seating	144
Fire Code Seating with COM	145
Wood Color Availability Matrix	146
Guidelines for Directional Fabrics	147

Surface Materials

This listing includes all the surface material choices that are available for the products in this specification guide.

Resources

For more information about surface materials, refer to the following resources:

Surface Materials Reference Manual

This publication provides:

- An explanation of the surface materials program
- “Available on” matrices
- Vertical surface fabric and seating upholstery selection listing
- Pricing for surface materials
- Technical data for surface materials
- Surface material care and cleaning instructions

Surface Materials

Finishes Binder includes:

- Surface Materials Reference Manual
- A complete set of swatch cards for hard surfaces

Surface Materials

Vertical Surface Fabric Binder includes:

- A complete set of swatch cards for vertical surface fabric

Surface Materials

Seating Upholstery Binder includes:

- Designtex Graded-In Catalog
- A complete set of swatch cards for seating upholstery

Surface Materials

Tool Box provides 3" x 3" samples of the following surface materials:

- Vertical surface fabric
 - Seating upholstery
 - Wood veneer
 - Paint
 - Laminate
- Form number S8150

Metal

- 7026 Nickel
- 7098 Sterling
- 7207 Black
- 9201 Polished Chrome

Wood

- ▶ See *Wood Color Availability Matrix* on page 146 for color availability by product line and wood species.
- Tip: The wood used in the construction of chairs is either maple or European beech. Wood finishes applied to maple or beech will match the color of stains applied to oak, walnut, or cherry, but will not have the same natural grain. Exception: Groove is a wood-veneered product.*

Wood Seating color choices

- 3412 Natural Cherry
- 3422 Medium Cherry
- 3562 Linseed
- 3572 Amber
- 3582 Winter
- 3592 Blonde
- 3632 Medium Oak
- 3642 Natural Oak
- 3712 Natural Walnut
- 3722 Dark Mahogany on Walnut
- 3742 Autumn Walnut
- 3772 Medium Mahogany on Walnut
- 3792 Black Walnut

Customiz stain is a service that allows you to create your own stain color. Minimum order quantities, per unit up-charges, and a one-time customer processing fee apply.

- ▶ See the *Surface Materials Reference Manual* for more information.

Plastic

Available on:

- Snodgrass 474 Series chair frames

- 6205 Black
- 6250 Coffee
- 6256 Graphite

Upholstery

Tip: Some of the vinyl colors listed below were slated to be culled in October 1999; however, they will remain available to existing customers indefinitely. A project is in process to improve the Steelcase seating vinyl color offering.

Classics Collection

Surface materials in the Classics Collection are timeless. These materials should be available for a minimum of 10 years from the date the material is introduced into the Classics Collection. The Classics Collection includes the following fabrics in Price Groups 1 through 3 and the Leather Price Group:

Price Group 1

Buzz2

- 5F00 Yellow
- 5F01 Camel
- 5F02 Orange
- 5F03 Tomato
- 5F04 Red
- 5F05 Burgundy
- 5F06 Sky
- 5F07 Blue
- 5F08 Navy
- 5F09 Blue-Green
- 5F10 Grape
- 5F11 Eggplant
- 5F12 Celery
- 5F13 Green
- 5F14 Forest
- 5F15 Stone
- 5F16 Grey
- 5F17 Black

Jacks

- 5B61 Taupe
- 5B62 Nutmeg
- 5B63 Camel
- 5B64 Pewter
- 5B65 Rosewood
- 5B66 Plum
- 5B67 Lupine
- 5B68 Lichen
- 5B69 Ocean
- 5B70 Midnight

Link

- 5A20 Burgundy
- 5A21 Rust
- 5A23 Green
- 5A24 Blue
- 5A25 Navy
- 5A26 Purple
- 5A27 Black
- 5A28 Ocean
- 5A29 Lichen
- 5A30 Chamois

Vinyl

- 5800 Cardinal
- 5801 Topaz
- 5802 Ocean
- 5803 Sky
- 5804 Lupine
- 5805 Foggy Night
- 5806 Aegean
- 5807 Harbor
- 5808 Eggplant
- 5809 Black
- 5810 Forest
- 5812 Navy
- 5813 Currant

Price Group 2

Canzoné

- 5514 Teal
- 5515 Raspberry
- 5517 Kiwi
- 5518 Plum
- 5519 Mauve
- 5521 Fog
- 5525 Nickel
- 5526 Beechnut
- 5529 Fennel
- 5531 Horizon

Cavalcade

- 5209 Charcoal
- 5215 Blueweed
- 5216 Tanbark
- 5217 Chicory
- 5218 Camel
- 5219 Lichen
- 5220 Sky
- 5225 Currant
- 5291 Mallard
- 5292 Ocean

Cricket

- 5A84 Plum
- 5A85 Camel
- 5A86 Charcoal
- 5A87 Black
- 5A88 Cinnamon
- 5A89 Rosewood
- 5A90 Currant
- 5A91 Spearmint
- 5A92 Sky
- 5A93 Midnight
- 5A94 Lichen
- 5A95 Ocean
- 5A96 Forest

Regis

- 5267 Black
- 5275 Blue Blue Violet
- 5282 Blue Blue Green
- 5283 Blue
- 5R02 Cardinal
- 5R11 Red Red Violet Value 5
- 5R12 Pachysandra
- 5R13 Celestial
- 5R16 Caribbean
- 5R17 Topaz

Roulette

- 5D29 Ocean
- 5D30 Taupe
- 5D31 Pewter
- 5D32 Sky
- 5D33 Cinnamon
- 5D34 Rosewood
- 5D35 Plum
- 5D36 Spearmint
- 5D37 Forest
- 5D38 Midnight

Spyder

- 5B00 Orchid
- 5B01 Foggy Night
- 5B04 Peri
- 5B05 Merlot
- 5B06 Dove
- 5B07 Sage
- 5B09 Topaz
- 5B10 Ocean
- 5B11 Currant
- 5B12 Lichen

Sweepstakes

- 5B80 Sky
- 5B81 Almond
- 5B82 Taupe
- 5B83 Charcoal
- 5B84 Nutmeg
- 5B85 Cinnamon
- 5B86 Currant
- 5B87 Opal
- 5B88 Plum
- 5B89 Midnight
- 5B90 Mist
- 5B91 Ocean
- 5B92 Forest

Price Group 3

Hampstead

- B351 Blue Green V4
- B359 Blue Blue Green V5
- B361 Blue V3 (Low Intensity)
- B363 Blue V4
- B366 Blue Blue Violet V4
- B369 Blue Blue Violet V5
- B377 Violet V5 (Low Intensity)
- B386 Red Red Violet V4 (Low Intensity)
- B389 Red Red Violet V5
- B395 Grey V5
- B399 Black
- B406 Windflower
- B407 Twinflower
- B408 Lupine
- B409 Cornflower
- B410 Aegean
- B412 Starflower
- B413 Shale
- B415 Taupe
- B416 Topaz
- B417 Saddle
- B418 Paprika
- B419 Cinnamon
- B420 Apple
- B421 Leaf

Zoe

5A09 Apricot
 5A10 Eggplant
 5A11 Avocado
 5A12 Cinnamon
 5A14 Peacock
 5A15 Rain
 5A16 Grey Flannel
 5A17 Ivory Cream
 5A19 Currant

Leather Price Group

L107 Black
 L202 Dusk
 L203 Bottle
 L207 Mahogany
 L220 Soapstone
 L221 Rocky
 L224 Plum
 L500 Camel
 L503 Navy
 L507 Vineyard

Note: Samples of the leather for Masque seating are not available. However, they are similar in color to Steelcase L107 Black and L507 Vineyard Leather.

Designtex Graded-In Program

All Designtex Graded-In fabrics are now supported just like standard fabrics when ordered on Steelcase furniture. The Designtex Graded-In Program also includes the Environmental Impact Collection which offers sustainable textiles in affordable price groups. For additional information and fabric samples, contact your local Designtex sales representative at 1.800.221.1540.

Designtex upholsteries are graded into Steelcase Price Groups 2 through 10:

Price Group 2**Bee (Environmental Impact Collection)**

5E44 Caspian
 5E45 Chamois
 5E46 Nutmeg
 5E47 Java
 5E48 Cinnamon
 5E49 Laquer
 5E50 Currant
 5E51 Lupine
 5E52 Prune
 5E53 Aubergine
 5E54 Sky
 5E55 Cadet
 5E56 Midnight
 5E57 Khaki
 5E58 Stem
 5E59 Pine
 5E60 Pond
 5E61 Tuscan
 5E62 Forest
 5E63 Taupe
 5E64 Pewter
 5E65 Raven

Price Group 3**Lagoon (Environmental Impact Collection)**

5D80 Pond
 5D81 Chamois
 5D82 Willow
 5D83 Java
 5D84 Nutmeg
 5D85 Cinnamon
 5D86 Currant
 5D87 Opal
 5D88 Crocus
 5D89 Aubergine
 5D90 Mist
 5D91 Cadet
 5D92 Midnight
 5D93 Lichen
 5D94 Spearmint
 5D95 Forest
 5D96 Sage
 5D97 Charcoal
 5D98 Raven

Prairie (Environmental Impact Collection)

5E66 Plum
 5E67 Chamois
 5E68 Pewter
 5E69 Dark Taupe
 5E70 Doe
 5E71 Luggage
 5E72 Java
 5E73 Mandarin
 5E74 Cinnabar
 5E75 Currant
 5E76 Watermelon
 5E77 Lupine
 5E78 Aubergine
 5E79 Lichen
 5E80 Stem
 5E81 Forest
 5E82 Sage
 5E83 Ocean
 5E84 Kale
 5E85 Cadet
 5E86 Sky
 5E87 Midnight
 5E88 Charcoal
 5E89 Cinder
 5E90 Raven

Reed Stripe (Environmental Impact Collection)

5D55 Java
 5D56 Willow
 5D57 Camel
 5D58 Charcoal
 5D59 Lichen
 5D60 Pond
 5D61 Cadet
 5D62 Nutmeg
 5D63 Paprika
 5D64 Currant
 5D65 Ocean
 5D66 Midnight
 5D67 Forest

Price Group 4**Bowline**

J568 Canyon
 J569 Beach
 J570 Paprika
 J571 Ocean
 J572 Leaf
 J573 Midnight
 J574 Smoke

Closed Loop

J589 Sand
 J590 Taupe
 J591 Saffron
 J592 Redwood
 J593 Lapis
 J594 Indigo
 J595 Robin's Egg
 J596 Willow
 J597 Malachite
 J598 Forest
 J599 Jade
 J600 Mahogany
 J601 Amethyst
 J602 Tangerine
 J603 Mineral
 J604 Black

Cord

J582 Canyon
 J583 Beach
 J584 Paprika
 J585 Ocean
 J586 Leaf
 J587 Midnight
 J588 Smoke

Croquet

5C54 Currant
 5C55 Almond
 5C56 Taupe
 5C57 Charcoal
 5C58 Camel
 5C59 Lichen
 5C60 Forest
 5C61 Mist
 5C62 Ocean
 5C63 Sky
 5C64 Cinnamon
 5C65 Rosewood
 5C66 Plum

Domino

5C34 Ocean
 5C35 Camel
 5C36 Charcoal
 5C37 Pewter
 5C38 Plum
 5C39 Rosewood
 5C40 Cinnamon
 5C41 Sky
 5C42 Midnight
 5C43 Forest

Montezuma

J335 Adobe
 J336 Jack Rabbit
 J337 Palomino
 J338 Tumbleweed
 J339 Citrus
 J340 Chili
 J341 Salsa
 J342 Cornflower
 J343 Azul
 J344 Lapis
 J345 Aqua
 J346 Peacock
 J347 Peyote

Nolita

J605 Almond
 J606 Earth
 J607 Sesame
 J608 Sunflower
 J609 Cherry
 J610 Cobalt
 J611 Glacier
 J612 Clover
 J613 Spruce
 J614 Iris
 J615 Terracotta
 J616 Graphite
 J617 Carbon

Rook

5E34 Lichen
 5E35 Almond
 5E36 Camel
 5E37 Pewter
 5E38 Opal
 5E39 Spearmint
 5E40 Sky
 5E41 Mandarin
 5E42 Lupine
 5E43 Cinnamon

Round About

J575 Canyon
 J576 Beach
 J577 Paprika
 J578 Ocean
 J579 Leaf
 J580 Midnight
 J581 Smoke

Skittles

5D42 Ocean
 5D43 Taupe
 5D44 Camel
 5D45 Nutmeg
 5D46 Lichen
 5D47 Sky
 5D48 Charcoal
 5D49 Plum
 5D50 Paprika
 5D51 Currant

Tango

- J081 Neutra
- J082 Deer
- J083 Elephant
- J084 Pascal
- J085 Borolo
- J086 Cosmos
- J087 Aegean
- J088 Ink
- J089 Aloe
- J090 Sherwood
- J091 Currant
- J092 Squash
- J093 Salt
- J094 Pepper

Tivoll

- 5C80 Spearmint
- 5C81 Camel
- 5C82 Almond
- 5C83 Pewter
- 5C84 Nutmeg
- 5C85 Cinnamon
- 5C86 Currant
- 5C87 Lichen
- 5C88 Plum
- 5C89 Sky

Vibe

- J548 Coconut
- J549 Sand
- J550 Malt
- J551 Root Beer
- J552 Champagne
- J553 Papaya
- J554 Cherry
- J555 Pool
- J556 Petal
- J557 Ocean
- J558 Slate
- J559 Key Lime
- J560 Palm Tree
- J561 Jam
- J562 Huckleberry
- J563 Sunrise
- J564 Snow Cone
- J565 Green Tea
- J566 Charcoal
- J567 Licorice

Wobble

- 5D16 Rosewood
- 5D17 Cinnamon
- 5D18 Paprika
- 5D19 Pewter
- 5D20 Camel
- 5D21 Lichen
- 5D22 Ocean
- 5D23 Sky
- 5D24 Plum
- 5D25 Midnight

Price Group 5

Abex

- J424 Dust
- J425 Rust
- J426 Chili Sauce
- J427 Titanic
- J428 Jungle
- J429 Amazon
- J430 Grape Slush

Frisbee

- 5C67 Sage
- 5C68 Chamois
- 5C69 Camel
- 5C70 Nutmeg
- 5C71 Spearmint
- 5C72 Ocean
- 5C73 Lichen
- 5C74 Sky
- 5C75 Plum
- 5C76 Midnight

Infield

- 5C44 Spearmint
- 5C45 Almond
- 5C46 Camel
- 5C47 Taupe
- 5C48 Cinnamon
- 5C49 Currant
- 5C50 Plum
- 5C51 Forest
- 5C52 Ocean
- 5C53 Midnight

Retreat

- 5D68 Taupe
- 5D69 Camel
- 5D70 Charcoal
- 5D71 Mist
- 5D72 Violet
- 5D73 Midnight
- 5D74 Spearmint
- 5D75 Lichen
- 5D76 Forest
- 5D77 Nutmeg
- 5D78 Cinnamon
- 5D79 Currant

Sam

- J360 Pebble
- J361 Cornsilk
- J362 Yolk
- J363 Ladybug
- J364 Cherry
- J365 Sky
- J366 Bluejay
- J367 Grass
- J368 Sweetpea
- J369 Jam
- J370 Grape
- J371 Goldfish
- J372 River
- J373 Stone

Price Group 6

Rough & Ready

- J431 Wheat
- J432 Field
- J433 Sand
- J434 Squirrel
- J435 Mink
- J436 Sun
- J437 Lemon
- J438 Pepper
- J439 Wine
- J440 Ink
- J441 Octopus
- J442 Icy
- J443 Cobalt
- J444 Lagoon
- J445 Brook
- J446 Kale
- J447 Leaf
- J448 Sprout
- J449 Concord
- J450 Raisin
- J451 Tiger
- J452 Cinnamon

Price Group 7

Ace

- J502 Beige
- J503 Camel
- J504 Red
- J505 Orange
- J506 Black
- J507 Gray

Firefly

- J250 Ash
- J251 Cashew
- J252 Currant
- J253 Firebee
- J254 Bleu
- J255 Riviera
- J256 Citrine
- J257 Verdant
- J258 Sherwood
- J259 Charcoal

Shimmy

- J106 Wheat
- J107 Lark
- J108 Amber
- J109 Chili
- J110 Moroccan
- J111 Artichoke
- J112 Foliage
- J113 Mulberry
- J114 Canyon
- J115 Feather
- J116 Storm

Wool Suede Too

- J457 Stone
- J458 Tan
- J459 Squash
- J460 Blush
- J461 Dust
- J462 Mineral
- J463 Sesame
- J464 Ginger
- J465 Eucalyptus
- J466 Patina
- J467 Green Tea
- J468 Pecan
- J469 China
- J470 Juniper
- J471 Olive
- J472 Persimmon
- J473 Charcoal
- J474 Ink
- J475 Jam
- J476 Cranberry
- J477 Shale
- J478 Black

Price Group 8

Coppice

- J374 Vanilla
- J375 Mushroom
- J376 Straw
- J377 Cardinal
- J378 Volcano
- J379 Cornflower
- J380 Marine
- J381 Larkspur
- J382 Regiment
- J383 Ivy
- J384 African Violet
- J385 Inca
- J386 Kangaroo
- J387 Gunmetal
- J388 Pewter

Delphos

- J117 Silver Birch
- J118 Champagne
- J119 Amber
- J120 Cedar
- J121 Cranberry
- J122 Marina
- J123 Blue Spruce
- J124 Hyacinth
- J125 Cypress
- J126 Ultra Violet
- J127 Damson
- J128 Flat Iron

Falling Leaves

- J314 Acorn
- J315 Barn
- J316 Spring
- J317 Forest
- J318 Meadow
- J319 Autumn

Furrows

- J320 Vanilla
- J321 Mushroom
- J322 Koala
- J323 Straw
- J324 Cardinal
- J325 Volcano
- J326 Cornflower
- J327 Marine
- J328 Larkspur
- J329 Regiment
- J330 Ivy
- J331 African Violet
- J332 Inca
- J333 Kangaroo
- J334 Gunmetal

Lillian

- J268 Silver Birch
- J269 Champagne
- J270 Butternut
- J271 Cedar
- J272 Marina
- J273 Blue Spruce
- J274 Hunter
- J275 Cypress
- J276 Hyacinth
- J277 Flat Iron

Loseta

- J389 Straw
- J390 Persimmon
- J391 Cassis
- J392 Bluestone
- J393 Briar
- J394 Crocus
- J395 Shale
- J396 Cattail

Meander

- J397 Mushroom
- J398 Straw
- J399 Volcano
- J400 Volcano Ivy
- J401 Marine
- J402 Larkspur
- J403 Regiment Volcano
- J404 Regiment
- J405 Ivy
- J406 Regiment Ivy
- J407 Violet Ivy
- J408 Inca Ivy
- J409 Kangaroo
- J410 Gunmetal
- J411 Pewter

Packard

J412	Porcelain
J413	Loden
J414	Camel
J415	Brass
J416	Pimpernel
J417	Gemstone
J418	Lapis
J419	Leaf
J420	Mint
J421	Patina
J422	Plum
J423	Cricket

Rickshaw

J479	Driftwood
J480	Ochre
J481	Cherry
J482	Midnight
J483	Pistachio
J484	Dusk
J485	Paprika

Price Group 9**Gramercy**

J647	Fawn
J648	Chocolate
J649	Stag
J650	Cordovan
J651	Claret
J652	Brook
J653	Navy
J654	Moss
J655	Bottle
J656	Hunter
J657	Brick
J658	Coal

NoMad

J486	Lager
J487	Peaches-n-Cream
J488	Tangerine
J489	Green Mint
J490	Limeade
J491	Smudge
J492	Sea Breeze
J493	Ice Blast
J494	Root Beer

Price Group 10**Plums**

J495	Fieldstone
J496	Celery
J497	Penny
J498	Pond
J499	Mulberry
J500	Iris
J501	Boysenberry

► See the *Surface Materials Reference Manual* for a listing of upholstery colors.

Price Group COM/COL (Customer's Own Material/Leather)**Fabric Approval and Yardage**

To confirm whether a particular COM material has already been tested for use on a specific Steelcase product or to determine actual yardage requirements:

- Visit www.steelcase.com
- Click on "Knowledge & Design"
- Select "Customer's Own Material"

You can find the same information on the in2 site.

Follow these steps:

- Visit www.in2.steelcase.com
- Click on "Sales/Design Team"
- Select "Surface Materials"
- Select "Customer's Own Material"

For additional information regarding Customer's Own Material, call 1.888.STEELCASE.

Wood Seating Upholstery Matrix

Not every fabric is available on every chair. This matrix gives an overview of the upholstery fabrics that can be specified on each seating product line.

	Price Group 1	Price Group 2	Price Group 2	Price Group 2	Price Group 3	Price Group 1	Price Group Leather	Price Group 1	Price Group 2	Price Group 2	Price Group 1	Price Group 2	Price Group 2	Price Group 3
	Buzz2	Canzoné	Cavalcade	Cricket	Hampstead	Jacks	Leather	Link	Regis	Roulette	Seating Vinyl	Spyder	Sweepstakes	Zoe
Alcove	■	■	■	■	■	■	■	■	■	■	•	■	■	■
Alerion	■	■	■	■	■	■	■	■	■	■	■	■	■	■
Ascot	■	■	■	■	■	■	■	■	■	■	■	■	■	■
Breton	•	•	•	•	•	•	■	•	•	•	•	•	•	•
Collaboration	■	■	■	■	■	■	■	■	■	■	•	■	■	■
Collegium	■	■	■	■	■	■	■	■	■	■	■	■	■	■
Community Lounge	■	■	■	■	■	■	■	■	■	■	■	■	■	■
Company	■	■	■	■	■	■	■	■	■	■	■	■	■	■
Dearborn	■	■	■	■	■	■	■	■	■	■	■	■	■	■
Deck	■	■	■	■	■	■	■	■	■	■	■	■	■	■
Decorum	■	■	■	■	■	■	■	■	■	■	■	■	■	■
England	■	■	■	■	■	■	■	■	■	■	■	■	■	■
Escapade	■	■	■	■	■	■	■	■	■	■	•	■	■	■
Étude	■	■	■	■	■	■	■	■	■	■	■	■	■	■
Gentry	■	■	■	■	■	■	■	■	■	■	■	■	■	■
Groove Lounge	■	■	■	■	■	■	■	■	■	■	■	■	■	■
Mansfield	■	■	■	■	■	■	■	■	■	■	■	■	■	■
Masque	•	•	•	•	•	•	□	•	•	•	•	•	•	•
Mingle	■	■	■	■	■	■	■	■	■	■	•	■	■	■
Oriana	■	■	■	■	■	■	■	■	■	■	•	■	■	■
Snodgrass	■	■	■	■	■	■	■	■	■	■	■	■	■	■
Terrazzo	■	■	■	■	■	■	■	■	■	■	■	■	■	■
Theorem	■	■	■	■	■	■	■	■	■	■	■	■	■	■
Topaz	■	■	■	■	■	■	■	■	■	■	•	■	■	■

Legend

- = Not available
- = Available
- = Available with exceptions
- ▶ See specification pages for details.

Note: Certain fabrics and leathers appear loose with comfort wrinkles when upholstered.

Designtex Graded-In Wood Seating Upholstery Matrix

Designtex Graded-In Wood Seating Upholstery Matrix

▶ See page 137 for Designtex Graded-In Program details.

	Alcove	Alerion	Ascot	Breton	Collaboration	Collegium	Community Lounge	Company	Dearborn	Deck	Decorum	England	Escapade	Etude	Gentry	Groove Lounge	Mansfield	Masque	Mingle	Oriana	Snodgrass	Terrazzo	Theorem	Topaz
Environmental Impact Collection																								
Bee Price Group 2	■	■	■	•	■	■	■	■	■	■	■	■	■	■	■	■	■	■	■	■	■	■	■	■
Lagoon Price Group 3	■	■	■	•	■	■	■	■	■	■	■	■	■	■	■	■	■	■	■	■	■	■	■	■
Prairie Price Group 3	■	■	■	•	■	■	■	■	■	■	■	■	■	■	■	■	■	■	■	■	■	■	■	■
Reed Stripe Price Group 3	■	■	■	•	■	■	■	■	■	■	■	■	■	■	■	■	■	■	■	■	■	■	■	■
Other Seating Upholstery																								
Abex Price Group 5	■	■	■	•	■	■	■	■	■	■	■	■	■	■	■	■	■	■	■	■	■	■	■	■
Ace Price Group 7	■	■	■	•	■	■	■	■	■	■	■	■	■	■	■	■	■	■	■	■	■	■	■	■
Bowline Price Group 4	■	■	■	•	■	■	■	■	■	■	■	■	■	■	■	■	■	■	■	■	■	■	■	■
Closed Loop Price Group 4	■	■	■	•	■	■	■	■	■	■	■	■	■	■	■	■	■	■	■	■	■	■	■	■
Coppice Price Group 8	■	■	■	•	■	■	■	■	■	■	■	■	■	■	■	■	■	■	■	■	■	■	■	■
Cord Price Group 4	■	■	■	•	■	■	■	■	■	■	■	■	■	■	■	■	■	■	■	■	■	■	■	■
Croquet Price Group 4	•	•	•	•	•	•	•	•	•	•	•	•	•	•	•	■	•	•	•	•	•	•	•	•
Delphos Price Group 8	■	■	■	•	■	■	■	■	■	■	■	■	■	■	■	■	■	■	■	■	■	■	■	■
Domino Price Group 4	■	■	■	•	■	■	■	■	■	■	■	■	■	■	■	■	■	■	■	■	■	■	■	■
Falling Leaves Price Group 8	■	■	■	•	■	■	■	■	■	■	■	■	■	■	■	■	■	■	■	■	■	■	■	■
Firefly Price Group 7	■	■	■	•	■	■	■	■	■	■	■	■	■	■	■	■	■	■	■	■	■	■	■	■
Frisbee Price Group 5	■	■	■	•	■	■	■	■	■	■	■	■	■	■	■	■	■	■	■	■	■	■	■	■
Furrows Price Group 8	■	■	■	•	■	■	■	■	■	■	■	■	■	■	■	■	■	■	■	■	■	■	■	■
Gramercy Price Group 9	■	■	■	•	■	■	■	■	■	■	■	■	■	■	■	■	■	■	■	■	■	■	■	■
Infield Price Group 5	■	■	■	•	■	■	■	■	■	■	■	■	■	■	■	■	■	■	■	■	■	■	■	■
Lillian Price Group 8	■	■	■	•	■	■	■	■	■	■	■	■	■	■	■	■	■	■	■	■	■	■	■	■
Loseta Price Group 8	■	■	■	•	■	■	■	■	■	■	■	■	■	■	■	■	■	■	■	■	■	■	■	■
Meander Price Group 8	■	■	■	•	■	■	■	■	■	■	■	■	■	■	■	■	■	■	■	■	■	■	■	■
Montezuma Price Group 4	■	■	■	•	■	■	■	■	■	■	■	■	■	■	■	■	■	■	■	■	■	■	■	■
Nolita Price Group 4	■	■	■	•	■	■	■	■	■	■	■	■	■	■	■	■	■	■	■	■	■	■	■	■
NoMad Price Group 9	■	■	■	•	■	■	■	■	■	■	■	■	■	■	■	■	■	■	■	■	■	■	■	■
Packard Price Group 8	■	■	■	•	■	■	■	■	■	■	■	■	■	■	■	■	■	■	■	■	■	■	■	■
Plums Price Group 10	■	■	■	•	■	■	■	■	■	■	■	■	■	■	■	■	■	■	■	■	■	■	■	■
Retreat Price Group 5	•	•	•	•	•	■	■	■	■	■	■	■	■	■	■	■	■	■	■	■	■	■	■	■
Rickshaw Price Group 8	■	■	■	•	■	■	■	■	■	■	■	■	■	■	■	■	■	■	■	■	■	■	■	■
Rook Price Group 4	■	■	■	•	■	■	■	■	■	■	■	■	■	■	■	■	■	■	■	■	■	■	■	■
Rough & Ready Price Group 6	■	■	■	•	■	■	■	■	■	■	■	■	■	■	■	■	■	■	■	■	■	■	■	■
Round About Price Group 4	■	■	■	•	■	■	■	■	■	■	■	■	■	■	■	■	■	■	■	■	■	■	■	■
Sam Price Group 5	■	■	■	•	■	■	■	■	■	■	■	■	■	■	■	■	■	■	■	■	■	■	■	■
Shimmy Price Group 7	■	■	■	•	■	■	■	■	■	■	■	■	■	■	■	■	■	■	■	■	■	■	■	■
Skittles Price Group 4	■	■	■	•	■	■	■	■	■	■	■	■	■	■	■	■	■	■	■	■	■	■	■	■
Tango Price Group 4	■	■	■	•	■	■	■	■	■	■	■	■	■	■	■	■	■	■	■	■	■	■	■	■
Tivoli Price Group 4	■	■	■	•	■	■	■	■	■	■	■	■	■	■	■	■	■	■	■	■	■	■	■	■
Vibe Price Group 4	■	■	■	•	■	■	■	■	■	■	■	■	■	■	■	■	■	■	■	■	■	■	■	■
Wobble Price Group 4	■	■	■	•	■	■	■	■	■	■	■	■	■	■	■	■	■	■	■	■	■	■	■	■
Wool Suede Too Price Group 7	■	■	■	•	■	■	■	■	■	■	■	■	■	■	■	■	■	■	■	■	■	■	■	■

Legend

- = Not available
- = Available
- = Available with exceptions
- ▶ See specification pages for details.

Fire Code Wood Seating Upholstery Matrix

Wood Seating Upholstery: Availability of Fire Code Treatment

Fire Code Seating (FCS) indicates that a product is constructed to meet the strict fire code requirements of high public occupancy areas.

The following matrix lists each seating line and denotes fabrics that are available, available with exceptions, and not available.

	1	2	2	2	3	1	Leather	1	2	2	1	2	2	3
	Buzz2	Canzoné	Cavalcade	Cricket	Hampstead	Jacks	Leather	Link	Regis	Roulette	Seating Vinyl	Spyder	Sweepstakes	Zoe
Alcove	•	■	■	•	■	■	■	■	■	■	•	■	■	■
Alerion	•	■	■	•	■	■	■	■	■	■	■	■	■	■
Ascot	•	□	□	•	□	□	■	□	□	□	■	■	■	□
Breton	•	•	•	•	•	•	•	•	•	•	•	•	•	•
Collaboration	•	■	■	•	■	■	■	■	■	■	•	■	■	■
Collegium	•	□	□	•	□	□	□	□	□	□	□	□	□	□
Community Lounge	•	■	■	•	■	■	■	■	■	■	■	■	■	■
Company	•	■	■	•	■	■	■	■	■	■	■	■	■	■
Dearborn	•	■	■	•	■	■	■	■	■	■	■	■	■	■
Deck	•	■	■	•	■	■	■	■	■	■	■	■	■	■
Decorum	•	□	□	•	□	□	□	□	□	□	■	□	□	□
England	•	□	□	•	□	□	□	□	□	□	■	□	□	□
Escapade	•	■	■	•	■	■	■	■	■	■	•	■	■	■
Étude	•	□	□	•	□	□	□	□	□	□	■	□	□	□
Gentry General-Use	•	□	□	•	□	□	■	□	□	□	■	□	□	□
Gentry Guest	•	□	□	•	□	□	■	□	□	□	■	□	□	□
Groove Lounge	•	■	■	•	■	■	■	■	■	■	■	■	■	■
Mansfield Executive	•	□	□	•	□	□	■	□	□	□	■	□	□	□
Mansfield Guest	•	□	□	•	□	□	■	□	□	□	■	□	□	□
Masque	•	•	•	•	•	•	•	•	•	•	•	•	•	•
Mingle	•	■	■	•	■	■	■	■	■	■	•	■	■	■
Oriana	•	■	■	•	■	■	■	■	■	■	•	■	■	■
Snodgrass	□	□	□	□	□	□	■	□	□	□	■	□	□	□
Terrazzo	•	■	■	•	■	■	■	■	■	■	■	■	■	■
Theorem	•	•	•	•	•	•	■	•	•	•	■	•	•	•
Topaz	•	■	■	•	■	■	■	■	■	■	•	■	■	■

Legend

- = Not available
- = Available
- = Available with exceptions
- ▶ See specification pages for details.

Fire Code Wood Seating Upholstery Matrix for Designtex

Fire Code Wood Seating
Upholstery Matrix for
Designtex

Designtex Graded-In

Wood Seating Upholstery: Availability of Fire Code Treatment

▶ See page 137 for Designtex Graded-In Program details.

	Alcove	Alerion	Ascot	Breton	Collaboration	Collegium	Community Lounge	Company	Dearborn	Deck	Decorum	England	Éscapade	Étude	Gentry	Groove Lounge	Mansfield	Masque	Mingle	Oriana	Snodgrass	Terrazzo	Theorem	Topaz
Environmental Impact Collection																								
Bee Price Group 2	•	•	•	•	•	•	•	•	•	•	•	•	•	•	•	•	•	•	•	•	•	•	•	•
Lagoon Price Group 3	•	•	•	•	•	•	•	•	•	•	•	•	•	•	•	•	•	•	•	•	□	•	•	•
Prairie Price Group 3	•	•	•	•	•	•	•	•	•	•	•	•	•	•	•	•	•	•	•	•	□	•	•	•
Reed Stripe Price Group 3	•	•	•	•	•	•	•	•	•	•	•	•	•	•	•	•	•	•	•	•	□	•	•	•
Other Seating Upholstery																								
Abex Price Group 5	•	•	•	•	•	•	•	•	•	•	•	•	•	•	•	•	•	•	•	•	•	•	•	•
Ace Price Group 7	•	•	•	•	•	•	•	•	•	•	•	•	•	•	•	•	•	•	•	•	•	•	•	•
Bowline Price Group 4	•	•	•	•	•	•	•	•	•	•	•	•	•	•	•	•	•	•	•	•	•	•	•	•
Closed Loop Price Group 4	•	•	•	•	•	•	•	•	•	•	•	•	•	•	•	•	•	•	•	•	□	•	•	•
Coppice Price Group 8	•	•	•	•	•	•	•	•	•	•	•	•	•	•	•	•	•	•	•	•	•	•	•	•
Cord Price Group 4	•	•	•	•	•	•	•	•	•	•	•	•	•	•	•	•	•	•	•	•	•	•	•	•
Croquet Price Group 4	•	•	•	•	•	•	•	•	•	•	•	•	•	•	•	•	•	•	•	•	•	•	•	•
Delphos Price Group 8	•	•	•	•	•	•	•	•	•	•	•	•	•	•	•	•	•	•	•	•	•	•	•	•
Domino Price Group 4	•	•	•	•	•	•	•	•	•	•	•	•	•	•	•	•	•	•	•	•	□	•	•	•
Falling Leaves Price Group 8	•	•	•	•	•	•	•	•	•	•	•	•	•	•	•	•	•	•	•	•	•	•	•	•
Firefly Price Group 7	•	•	•	•	•	•	•	•	•	•	•	•	•	•	•	•	•	•	•	•	•	•	•	•
Frisbee Price Group 5	•	•	•	•	•	•	•	•	•	•	•	•	•	•	•	•	•	•	•	•	•	•	•	•
Furrows Price Group 8	•	•	•	•	•	•	•	•	•	•	•	•	•	•	•	•	•	•	•	•	•	•	•	•
Gramercy Price Group 9	■	■	□	•	■	□	■	■	■	■	□	□	■	□	□	■	□	•	■	■	□	■	■	■
Infield Price Group 5	•	•	•	•	•	•	•	•	•	•	•	•	•	•	•	•	•	•	•	•	□	•	•	•
Lillian Price Group 8	•	•	•	•	•	•	•	•	•	•	•	•	•	•	•	•	•	•	•	•	•	•	•	•
Loseta Price Group 8	•	•	•	•	•	•	•	•	•	•	•	•	•	•	•	•	•	•	•	•	•	•	•	•
Meander Price Group 8	■	■	□	•	■	□	■	■	■	■	□	□	■	□	□	■	□	•	■	■	□	■	■	■
Montezuma Price Group 4	■	■	□	•	■	□	■	■	■	■	□	□	■	□	□	■	□	•	■	■	□	■	■	■
Nolita Price Group 4	•	•	•	•	•	•	•	•	•	•	•	•	•	•	•	•	•	•	•	•	•	•	•	•
NoMad Price Group 9	•	•	•	•	•	•	•	•	•	•	•	•	•	•	•	•	•	•	•	•	•	•	•	•
Packard Price Group 8	■	■	□	•	■	□	■	■	■	■	□	□	■	□	□	■	□	•	■	■	□	■	■	■
Plums Price Group 10	•	•	•	•	•	•	•	•	•	•	•	•	•	•	•	•	•	•	•	•	•	•	•	•
Rickshaw Price Group 8	•	•	•	•	•	•	•	•	•	•	•	•	•	•	•	•	•	•	•	•	•	•	•	•
Retreat Price Group 5	•	•	•	•	•	•	•	•	•	•	•	•	•	•	•	•	•	•	•	•	•	•	•	•
Rook Price Group 4	•	•	•	•	•	•	•	•	•	•	•	•	•	•	•	•	•	•	•	•	•	•	•	•
Rough & Ready Price Group 6	•	•	•	•	•	•	•	•	•	•	•	•	•	•	•	•	•	•	•	•	•	•	•	•
Round About Price Group 4	•	•	•	•	•	•	•	•	•	•	•	•	•	•	•	•	•	•	•	•	•	•	•	•
Sam Price Group 5	•	•	•	•	•	•	•	•	•	•	•	•	•	•	•	•	•	•	•	•	•	•	•	•
Shimmy Price Group 7	•	•	•	•	•	•	•	•	•	•	•	•	•	•	•	•	•	•	•	•	•	•	•	•
Skittles Price Group 4	■	■	■	•	■	□	■	■	■	■	□	□	■	□	□	■	□	•	■	■	□	■	•	■
Tango Price Group 4	•	•	•	•	•	•	•	•	•	•	•	•	•	•	•	•	•	•	•	•	□	•	•	•
Tivoli Price Group 4	•	•	•	•	•	•	•	•	•	•	•	•	•	•	•	•	•	•	•	•	•	•	•	•
Vibe Price Group 4	•	•	•	•	•	•	•	•	•	•	•	•	•	•	•	•	•	•	•	•	□	•	•	•
Wobble Price Group 4	•	•	•	•	•	•	•	•	•	•	•	•	•	•	•	•	•	•	•	•	•	•	•	•
Wool Suede Too Price Group 7	■	■	□	•	■	□	■	■	■	■	□	□	■	□	□	■	□	•	■	■	□	■	•	■

Legend

- = Not available
- = Available
- = Available with exceptions
- ▶ See specification pages for details.

Surface Materials

Fire Code Seating (FCS) Exceptions for Wood Seating

The Fire Code Seating (FCS) modification is available on nearly all Wood seating. There are some chair and fabric combinations that will not pass the test criteria for Fire Code Seating. This is often due to the chair configuration, large surface areas that support combustion, and the fiber content of some fabrics. For your convenience, we have listed the chair line exception models and the fabric combinations that **are available**. If a fabric is not listed, it is not available with the FCS option on the exception chair models.

Ascot

Ascot enclosed-arm models 296 and 276 and all variations of these models **are available** with FCS modification in the following fabrics only:

- Leather
- Seating Vinyl

Breton is not available with the FCS modification.

Collegium

Collegium enclosed-arm models 411 and 421 and all variations of these models **are available** with FCS modification in the following fabrics only:

- Leather
- Seating Vinyl

Decorum

Decorum enclosed-arm models 211 and 221 and all variations of these models **are available** with FCS modification in the following fabrics only:

- Leather
- Seating Vinyl

England

England enclosed-arm model 0113 **is available** with FCS in the following fabrics only:

- Leather
- Seating Vinyl

Étude

Étude club chair 0811 **is available** with FCS modification in the following fabrics only:

- Leather
- Seating Vinyl

Gentry

Gentry enclosed-arm models 0644W, 0634W, 0644B, 0634B, and all variations of these models **are available** with FCS modification in the following fabrics only:

- Leather
- Seating Vinyl

Mansfield

Mansfield high-back model 140 and all variations of this model **are available** with FCS modification in the following fabrics only:

- Leather
- Seating Vinyl

Masque is not available with the FCS modification.

Snodgrass

Snodgrass enclosed-arm model 474427W and all variations of this model **are available** with FCS modification in the following fabrics only:

- Leather
- Seating Vinyl

The Fire Code Seating option is available on certain chairs with COM. Fire code approval is based on chair model and specific textile combinations.

To find out if a specific COM is FCS approved on a Steelcase seating product, check the COM Web site at www.Steelcase.com:

- Click on “Knowledge & Design”
- Click on “Customer’s Own Material”
- Click on “Fabric test results”

In this matrix, there is a “FC” (fire code) line for each fabric, with a code word that describes the fabric’s availability on each chair line:

- “All” means that the fabric in question is available as FCS on all models of the chair line.
- “Restricted” means that the fabric is available as FCS on some models of the chair line.
- “Unknown” means that the fabric has to be qualified as FCS on that chair line.
- “None” means that the fabric is not available as FCS on that chair line.

Due to the many different combinations of fabric contents and changes that could be made by Steelcase to seating models, fabrics that have been previously approved for fire code may need to be re-tested for qualification.

For complete information about specifying COM on FCS modified chairs, call your Steelcase COM consultant at 616.475.2426 or fax inquiries to: 616.698.4700. Please provide the following information about your COM when making an inquiry:

- Supplier and fabric name
- Flammability testing
- Topical treatments
- Fabric weight
- Fiber content of the fabric
- Seating model number intended for application

The price for the FCS modification with COM is \$50 U.S. on all non-wood seating units and \$80 U.S. on all wood seating units. Please add the price to Price Group COM column within each Steelcase price list.

FCS Testing

Please submit a COM Application Testing Request form for FCS evaluation prior to sending any fabric. A COM consultant will contact you with more information.

Yardage requirements will vary per chair test. If your material requires FCS testing, submit a completed COM application Testing Request form and material to: Steelcase Inc.
Attn: COM Testing
Door 305
4060 Eastern Avenue
Grand Rapids, MI 49508

\$700 net testing fee is required for a full scale chair burn test. FCS testing lead time is 3-4 weeks.

Flame Retardance of COM Fabrics

Steelcase assumes no liability for COM fabrics with a flame-retardant finish and recommends that samples of the fabrics in question be submitted to the proper authority for certification.

If a flame-retardant finish is required, please advise your Steelcase Sales Services representative or regional office of the following information:

- Flammability code that must be passed
- Application of the fabric to be finished (i.e., upholstery, wall, panel, etc.)
- Weight of the fabric
- Need to apply other chemicals to the fabric (i.e., soil repellents)
- Type of backing
- Yardage requirements

With this information, Steelcase can contact the appropriate outside finisher and generate a quote. Treatment prices vary with quantity and fabric selection.

Wood Color Availability Matrix

Not every wood color is available on every seating component. This matrix gives an overview of which wood colors can be specified for each seating component.

Species or type of wood			3412 Natural Cherry	3422 Medium Cherry	3562 Linseed	3572 Amber	3582 Winter	3592 Blonde	3632 Medium Oak	3642 Natural Oak	3712 Natural Walnut	3722 Dark Mahogany on Walnut	3742 Autumn Walnut	3772 Med Mahogany on Walnut	3792 Black Walnut
Alcove	Frame	European Beech	■	■	■	■	■	■	■	■	■	■	■	■	■
Alerion	Frame	Maple	■	■	■	■	■	■	■	■	■	■	■	■	■
Ascot	Base	European Beech	■	■	■	■	■	■	■	■	■	■	■	■	■
Breton	Base caps	Maple	■	■	■	■	■	■	■	■	■	■	■	■	■
Collaboration	Frame and inserts	Maple	■	■	■	■	■	■	■	■	■	■	■	■	■
Collegium	Base and arms	Maple	■	■	■	■	■	■	■	■	■	■	■	■	■
Company	Frame and legs	Maple	■	■	■	■	■	■	■	■	■	■	■	■	■
Dearborn	Base and arms	Maple	■	■	■	■	■	■	■	■	■	■	■	■	■
Deck	Frame	Maple	■	■	■	■	■	■	■	■	■	■	■	■	■
	Table top	Cherry, Maple, Oak, and Walnut*	■	■	■	■	■	■	■	■	■	■	■	■	■
Decorum	Base and arms	Maple	■	■	■	■	■	■	■	■	■	■	■	■	■
England	Frame	Maple	■	■	■	■	■	■	■	■	■	■	■	■	■
Escapade	Frame	European Beech	■	■	■	■	■	■	■	■	■	■	■	■	■
Étude	Base and legs	Maple	■	■	■	■	■	■	■	■	■	■	■	■	■
Gentry	Base, arms, and frame	Maple	■	■	■	■	■	■	■	■	■	■	■	■	■
Groove	Base, tables, and tablet arms	Cherry, Maple, Oak, and Walnut*	■	■	■	■	■	■	■	■	■	■	■	■	■
Mansfield	Frame, back, and arms	Maple	■	■	■	■	■	■	■	■	■	■	■	■	■
Mingle	Legs, back, and arms	Maple	■	■	■	■	■	■	■	■	■	■	■	■	■
Oriana	Frame	Maple	■	■	■	■	■	■	■	■	■	■	■	■	■
Snodgrass	Frame and arms	Maple	■	■	■	■	■	■	■	■	■	■	■	■	■
Terrazzo	Frame and back slats	Maple	■	■	■	■	■	■	■	■	■	■	■	■	■
Theorem	Base	Maple	■	■	■	■	■	■	■	■	■	■	■	■	■
Topaz	Frame and arms	European Beech	■	■	■	■	■	■	■	■	■	■	■	■	■

Tip: The wood used in the construction of chairs is either maple or European beech. Wood finishes applied to maple or beech will match the color of stains applied to oak, walnut, or cherry but will not have the same natural grain.

**Groove and Deck tables are wood-veneered product lines.*

Legend

- = Not available
- = Available
- = Available with exceptions
- ▶ See specification pages for details.

What is the issue?

Some textiles are plain and look the same regardless of which direction the fabric is applied to the product. But many customers prefer fabrics that have patterns that give a clear direction to the textile. Because there are limits to how directional fabrics can be applied to panels and chairs, it is important to understand directional fabrics to avoid being disappointed.

Talking about direction

Fabrics come on rolls. The long threads that run parallel to the length of the roll are called the warp. The perpendicular threads that run parallel to the width of the roll are called the filling.

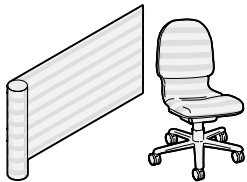

Railroaded means the height dimension of the product is perpendicular to the warp of the fabric; *warp horizontal* and *across roll* are other terms for running the fabric in this direction. All Steelcase standard fabrics are railroaded. The yardage requirements for railroaded cutting are calculated using the width of the fabric, quantity ordered, style of chair(s), and pattern repeat.



Woven way means the height dimension of the product is parallel to the warp of the fabric; *warp vertical* and *down roll* are other terms for running the fabric in this direction. The yardage requirements for woven way cutting are calculated using the width of the fabric, quantity ordered, and style of chair(s).

What determines fabric direction?

The width of the roll of fabric and the techniques that are used to apply it to the product can both determine the direction. Standard default direction for seating products with Steelcase standard fabrics is railroaded. No exceptions are possible. COM fabrics are standard woven way. You may specify a COM fabric to be cut in a specific direction if the product allows it to be applied. The purchase order must clearly state the cutting direction if it is other than standard.

Tip: If you are changing the cutting direction of fabric, yardage requirements may increase, resulting in an additional upcharge. This upcharge will be applied to the purchase order.

► See *Yardage Requirements* in the *Surface Materials Reference Manual* for specific information.

If you have any questions regarding cutting direction guidelines, please contact a Steelcase COM consultant at 616.246.9822 or 1-888-STEELCASE. You can also find this information on our Web site:

- Visit www.steelcase.com
- Click on "Knowledge & Design"
- Select "Customer's Own Material"

COM pattern exceptions

Sometimes COM fabrics have patterns that look awkward or inappropriate if they are applied in the standard direction (woven way). Those cases are addressed with these two pattern exception rules.



Incorrect



Correct



Incorrect



Correct

1

Fabrics with stripes or flame stitch will be applied so that the patterns are vertical.



Incorrect



Correct



Incorrect



Correct

2

Fabrics with patterns of people, vines, or flower arrangements will be applied so that the pattern is vertical.



Resources

Style Number Index

150

Style Number Index

Style Number	Page	Description
0113	65	England Guest Chr
0114	65	England Guest Chr
0202	81	Oriana Guest Chr
0204	81	Oriana Guest Chr
0205	81	Oriana Guest Chr
0612W	71	Gentry Guest Chr
0632B	53	Gentry LowBk Desk Chr
0632BK	53	Gentry LowBk Desk Chr
0632BN	53	Gentry LowBk Desk Chr
0633W	51	Gentry LowBk Desk Chr
0633WK	51	Gentry LowBk Desk Chr
0633WN	51	Gentry LowBk Desk Chr
0634B	53	Gentry LowBk Desk Chr
0634BK	53	Gentry LowBk Desk Chr
0634BN	53	Gentry LowBk Desk Chr
0634W	51	Gentry LowBk Desk Chr
0634WK	51	Gentry LowBk Desk Chr
0634WN	51	Gentry LowBk Desk Chr
0643W	51	Gentry HiBk Desk Chr
0643WK	51	Gentry HiBk Desk Chr
0643WN	51	Gentry HiBk Desk Chr
0644B	53	Gentry HiBk Desk Chr
0644BK	53	Gentry HiBk Desk Chr
0644BN	53	Gentry HiBk Desk Chr
0644W	51	Gentry HiBk Desk Chr
0644WK	51	Gentry HiBk Desk Chr
0644WN	51	Gentry HiBk Desk Chr
0701	59	Alerion Guest Chr
0702	59	Alerion Guest Chr
0811	116	Etude Club Chr
0812	117	Etude Love Seat
0813	117	Etude Sofa
0D31	111	Dearborn Lounge Chr
0D41	112	Dearborn Sofa
120	63	Collaboration Guest Chr
120B	63	Collaboration Guest Chr
120C	63	Collaboration Guest Chr
120CB	63	Collaboration Guest Chr
120CD	63	Collaboration Guest Chr
120CE	63	Collaboration Guest Chr
120CL	63	Collaboration Guest Chr
120CR	63	Collaboration Guest Chr
120CU	63	Collaboration Guest Chr
120D	63	Collaboration Guest Chr
120E	63	Collaboration Guest Chr
120L	63	Collaboration Guest Chr
120R	63	Collaboration Guest Chr
120U	63	Collaboration Guest Chr
140	32	Mansfield Desk Chair
141	32	Mansfield Desk Chair
142	74	Mansfield Guest Chr
144	75	Mansfield Guest Chr
211	29	Decorum HiBk Desk Chr
211N	29	Decorum HiBk Desk Chr
211NS	29	Decorum HiBk Desk Chr

Style Number	Page	Description
211NSX	29	Decorum HiBk Desk Chr
211NX	29	Decorum HiBk Desk Chr
211S	29	Decorum HiBk Desk Chr
211SX	29	Decorum HiBk Desk Chr
211X	29	Decorum HiBk Desk Chr
212	29	Decorum HiBk Desk Chr
212N	29	Decorum HiBk Desk Chr
212NS	29	Decorum HiBk Desk Chr
212NSX	29	Decorum HiBk Desk Chr
212NX	29	Decorum HiBk Desk Chr
212S	29	Decorum HiBk Desk Chr
212SX	29	Decorum HiBk Desk Chr
212X	29	Decorum HiBk Desk Chr
221	29	Decorum MidBk Desk Chr
221N	29	Decorum MidBk Desk Chr
221NS	29	Decorum MidBk Desk Chr
221NSX	29	Decorum MidBk Desk Chr
221NX	29	Decorum MidBk Desk Chr
221S	29	Decorum MidBk Desk Chr
221SX	29	Decorum MidBk Desk Chr
221X	29	Decorum MidBk Desk Chr
222	29	Decorum MidBk Desk Chr
222N	29	Decorum MidBk Desk Chr
222NS	29	Decorum MidBk Desk Chr
222NSX	29	Decorum MidBk Desk Chr
222NX	29	Decorum MidBk Desk Chr
222S	29	Decorum MidBk Desk Chr
222SX	29	Decorum MidBk Desk Chr
222X	29	Decorum MidBk Desk Chr
275	47	Ascot LowBk Desk Chr
275L	47	Ascot LowBk Desk Chr
275LN	47	Ascot LowBk Desk Chr
275N	47	Ascot LowBk Desk Chr
276	47	Ascot LowBk Desk Chr
276L	47	Ascot LowBk Desk Chr
276LN	47	Ascot LowBk Desk Chr
276N	47	Ascot LowBk Desk Chr
295	47	Ascot HiBk Desk Chr
295L	47	Ascot HiBk Desk Chr
295LN	47	Ascot HiBk Desk Chr
295N	47	Ascot HiBk Desk Chr
296	47	Ascot HiBk Desk Chr
296L	47	Ascot HiBk Desk Chr
296LN	47	Ascot HiBk Desk Chr
296N	47	Ascot HiBk Desk Chr
300	36	Masque HiBk Desk Chr
305	36	Masque HiBk Desk Chr
411	25	Collegium HiBk Desk Chr
411N	25	Collegium HiBk Desk Chr
411NS	25	Collegium HiBk Desk Chr
411NSX	25	Collegium HiBk Desk Chr
411NX	25	Collegium HiBk Desk Chr
411S	25	Collegium HiBk Desk Chr
411SX	25	Collegium HiBk Desk Chr
411X	25	Collegium HiBk Desk Chr

Style Number	Page	Description	Style Number	Page	Description
412	25	Collegium HiBk Desk Chr	DECKA2	101	Deck Guest Chr
412N	25	Collegium HiBk Desk Chr	DECKA3	101	Deck Guest Chr
412NS	25	Collegium HiBk Desk Chr	DECKC14	101	Deck Guest Chr
412NSX	25	Collegium HiBk Desk Chr	DECKC15	101	Deck Guest Chr
412NX	25	Collegium HiBk Desk Chr	DECKC24	101	Deck Guest Chr
412S	25	Collegium HiBk Desk Chr	DECKC25	101	Deck Guest Chr
412SX	25	Collegium HiBk Desk Chr	DECKC34	101	Deck Guest Chr
412X	25	Collegium HiBk Desk Chr	DECKC35	101	Deck Guest Chr
421	25	Collegium MidBk Desk Chr	DECKFT	102	Deck Table
421N	25	Collegium MidBk Desk Chr	DECKLT	102	Deck Table
421NS	25	Collegium MidBk Desk Chr	DECKS1	104	Deck Stool
421NSX	25	Collegium MidBk Desk Chr	DECKS2	104	Deck Stool
421NX	25	Collegium MidBk Desk Chr	DECKS3	104	Deck Stool
421S	25	Collegium MidBk Desk Chr	DT1818	103	Deck Table
421SX	25	Collegium MidBk Desk Chr	DT2415	103	Deck Table
421X	25	Collegium MidBk Desk Chr	G20	57	Alcove Guest Chr
422	25	Collegium MidBk Desk Chr	G22	68	Escapade Guest Chr
422N	25	Collegium MidBk Desk Chr	G23	68	Escapade Guest Chr
422NS	25	Collegium MidBk Desk Chr	G24	92	Topaz Guest Chr
422NSX	25	Collegium MidBk Desk Chr	G26	92	Topaz Guest Chr
422NX	25	Collegium MidBk Desk Chr	GVARM	128	Groove Round Arm Kit
422S	25	Collegium MidBk Desk Chr	GVBLKIT	129	Groove Block Back Kit
422SX	25	Collegium MidBk Desk Chr	GVBRKT	134	Groove Ganging Bracket
422X	25	Collegium MidBk Desk Chr	GVCHBL	122	Groove Block Back Chr
474410M	85	Snodgrass 474 Guest Chr	GVCHBLM	122	Groove Block Back Chr
474419M	85	Snodgrass 474 Guest Chr	GVCHSL	123	Groove Sail Back Chr
474419W	85	Snodgrass 474 Guest Chr	GVCHSLM	123	Groove Sail Back Chr
474420M	85	Snodgrass 474 Guest Chr	GVCSTR	133	Groove Casters
474427W	85	Snodgrass 474 Guest Chr	GVCUSH	131	Groove Cushion
474429M	85	Snodgrass 474 Guest Chr	GVDDBOX	134	Groove Data/Data Box
474429W	85	Snodgrass 474 Guest Chr	GVLEG	133	Groove Legs
497147MW	20	Breton MidBk Desk Chr	GVLGACR	132	Groove Table Top
497187MW	20	Breton HiBk Desk Chr	GVOTT	124	Groove Ottoman
497647MW	21	Breton Conference Chr	GVOTTM	124	Groove Ottoman
711	41	Theorem HiBk Desk Chr	GVPDBOX	134	Groove Power/Data Box
711N	41	Theorem HiBk Desk Chr	GVPLW	130	Groove Sail Back Pillow
711NS	41	Theorem HiBk Desk Chr	GVPPOBOX	134	Groove Power/Power Box
711NSX	41	Theorem HiBk Desk Chr	GVSHLF	132	Groove Shelf Kit
711NX	41	Theorem HiBk Desk Chr	GVSLKIT	129	Groove Sail Back Kit
711S	41	Theorem HiBk Desk Chr	GVSMACR	132	Groove Table Top
711SX	41	Theorem HiBk Desk Chr	GVTABLET	128	Groove Tablet Arm Kit
711X	41	Theorem HiBk Desk Chr	GVTBL	126	Groove Table
721	41	Theorem MidBk Desk Chr	GVTBLGR	126	Groove Table with Grommets
721N	41	Theorem MidBk Desk Chr	GVTBLGRM	126	Groove Table with Grommets
721NS	41	Theorem MidBk Desk Chr	GVTBLM	126	Groove Table
721NSX	41	Theorem MidBk Desk Chr	GVTBLTOP	127	Groove Table with Top
721NX	41	Theorem MidBk Desk Chr	GVTBLTOPM	127	Groove Table with Top
721S	41	Theorem MidBk Desk Chr	GVTBSHF	127	Groove Table with Top and Shelf
721SX	41	Theorem MidBk Desk Chr	GVTBSHFM	127	Groove Table with Top and Shelf
721X	41	Theorem MidBk Desk Chr	GVTBSUPP	132	Groove Table Top Support Kit
CCL1	109	Community Lounge Seating	MNGLB	78	Mingle Guest Chr
CCL2	109	Community Lounge Seating	MNGLBW	78	Mingle Guest Chr
CCL3	109	Community Lounge Seating	TERR1	88	Terrazzo Guest Chr
COMPY1	96	Company Guest Chr	TERR2	88	Terrazzo Guest Chr
COMPY2	96	Company Guest Chr	TERR3	88	Terrazzo Guest Chr
DECKA1	101	Deck Guest Chr			

Trademark List

® The following registered trademarks are used under license from Steelcase Development Corporation: Accelerate, Addition, Ally, Answer, Anthem, Arrondi, Avenir, Ballet, Bix, Brayton International Collection, Brayton Textile Collection, Breton, Broadmoor, CaneCreek, Canto, Chancellor, Collegium, Company, Concentrx, Conjunction, Context, Criterion, Crushed Can, Decorum, Designtex, Details, Diva, Drive, Elective Elements, Ellipse, Ember Chrome, Emerge, Etude, Exclamation Mark, Firstfile, Gentry, Ginkgo, Ginkgo Biloba, Hardwear, Ideo, Internode, Jersey, Kart, Kick, LaCosta, Latour, Leap, Let's B, Lucy, Lyra, Lytyn, Manhattan Product Configuration, Max-Stacker, Media Dock, Metro, Migrations, Miko, Montage, Oriana, Paladin, Paperflo, Parade, Paradigm, Pathways, Perfect Match, Player, Power Pincher, Portal, Protégé, Raf System, Rally, Rapport, Relevant, Reply, Secant, Segment, Sensor, Series 9000, Springboard, Steelcase, Steelcase Design Partnership, Steelcase Workplace Performance, Stow Davis, TeamWork, Technique, Texpress, Treehouse, Trilogy, Turnstone, Valencia, Vecta, Vectaflex, Werndl, Wizard, and Workflo.

® The following is a registered trademark of Genlyte Thomas Company, Louisville, KY: Lightolier.

® The following is a registered trademark of Leviton Manufacturing Company, Little Neck, NY: Decora.

® The following is a registered trademark of Microsoft Corporation, Redmond, WA: Microsoft.

® The following is a registered trademark of Panduit Corporation, Lockport, IL: Panduit.

® The following is a registered trademark of Trav (Press), Cuneo, Italy: Assisa.

® The following is a registered trademark of Virtual Ink Corporation: mimioActive.

® The following registered trademarks are under license from Wilkhahn Furniture Products: Avera, Confair, Senzo, Versal, and Wilkhahn FS.

™ The following trademarks are used under license from Steelcase Development Corporation: 4 o'clock, à la carte, Active/Passive Shelf, Activity Products, Adia, Alcove, Alerion, Alexander Street Collection, Aliso, Allegro, Alongside, American Elect, American Tradition, Anson, Arbor, Archipelago, Archive Collection, Arriva, Ascot, Astor, Austin, Avalon, Bira, Bonn, Boomerang, Bradbury, Breadbox, Brio, Buxton, Cachet, Callahan, Camber, Canopy, Cappucino, Catalina, CbP, Chester, Chorus, Chronos, Churchill, Ciao, Clarendon, Classic Rectangular, Collaboration, Collins, Cologne, Colorbox, Common (Shelf), Commons, Community, Community Base Planning, Convene, Convey, Cortex, Cosima, Croix, Cubby, Cubis, Cushion, Customiz, Dataduct, Datum, Debut, Deck, Dedoes, Déjà, Detour, Detriana, DNA, Domain, Donovan, Dorchester, Downspout, Drop Top Hutch, Duospace, Eastlake, Eastridge, Eco, Ella, Elsa, Emmy, Encounter, Enea, EnSync, Ensemble, Entourage, Environmental Impact Collection, Equinox, Escapade, Et Al, E-Table, Exponents, Express12, Extreme Conditions, Fillmore, Flat Top, Fling, Flip Top, Footnote, Fortuna, Frontier, Fuji, Futu, Galilei, Galveston, Garland, Ginger, Glenwood, Go Wall, Greco, Greenbrier, Grip, Groove, Groupwork, Hannah, Hatch, Hatchback, Hatteras, Health Design, Hitch, Huddleboard, Impact, Incognito, Indy, InfoWizard, InterAct, IOS, I-Solve, Jacket, Jenny, Jetty, Juice, Kendo, Kiana, L'Attitude, Lazlo, Lean Too, Lemon, Lift-N-Slide, Lotus, Lyric, M/O, Malibu, Manhattan, Mansfield, Martini, Masque, Mingle, Monarch, Monterey, Montreal, MyWizard, Nadia, Nickel, Nine, Ontrak, Onyx, Outlook, Paloma, Parliament, Parts Advantage, Pasio, Passarelle, Patriarch, Patterson, Payback, Peek, Pendio, Personal Border, Pier Top, Pipe, Pisa, Playback, Portal, Progeny, Quotient, Radio, Rag Top, Rei, Request, Reunion, Rhine, Rialto, Ricetta, Riser, Rizzi Arc, Rocco, RoomWizard, Rover, Runaround, Runner, Satellite, Scribe, Shadow, Shield, Shortbed, Skinny, Sidebar, Sidewalk, Sieste, Sine, Smoke, Snug, Softwork, Spinz, Sportswear, St. Clair, Stafford, Stationkits, Stiletto, Stuttgart, Super Shelf, Surprise!, Switch, Tableau, Taco, Template, Terrazzo, Tessare, Theorem, Think, Topaz, Topo, Top Spin, Touchdown, Translations, Train, Trolley, T-Wall, Umbrella, Underline, Unison, Uno, Utility Bar, Venetia, Walden, Warehouse, Whittier, Windsor, Wizard WebSigns, Your Profile, Your Power, and Your Preference.

™ The following is a trademark of Microsoft Corporation, Redmond, WA: Windows.

™ The following is a trademark of Ultrafabrics, LLC, Elmsford, NY: Ultraleather.

™ The following trademarks are used under license from Wilkhahn Furniture: Cana, Linus, Logon, Picto, Range, Stitz, Thema, Timetable, and Tubis.