

---

# Zetro

Veneer

Zetro Veneer



**PRODUCT SPECIFICATIONS**

**FINISHES**

- MH Mocha      • CW Cordovan      • MC Amber
- AC Autumn    • HN Honey

**TOPS**

- Grain direction runs left to right unless noted
- 1<sup>1</sup>/<sub>16</sub>" slipmatched maple veneer
- Worksurfaces feature a veneer banded flat edge profile

**CHASSIS CONSTRUCTION**

- Grain direction runs vertical
- ¾" pedestals
- All units feature fully finished backs unless noted
- Kneewell areas feature wood chassis finish
- ¾" thick modesty panels
- ¾" thick end panels
- End panels and modesty panels feature a ½" inset galvanized steel applique design on all units unless noted

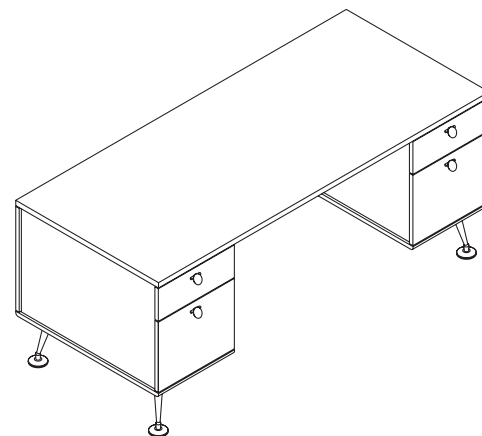

**PULLS**

- Chrome back plate with platinum finish on front dish

**LEGS**

- Platinum powder coated
- Legs are included with unit but must be field installed; units include pre-bored holes

**DOOR KITS**

- Medium density fiberboard frame
- Platinum thermofoil vinyl wrapped overlay
- Mitered dowel corners
- Translucent plastic panel insert
- Platinum knobs

**DRAWER INTERIORS**

- Drawers feature five-sided construction allowing for easy removal of drawer fronts
- Sides, back and front are woodgrain vinyl wrapped ½" thick
- Drawer fronts are 3-ply construction with matched woodgrain
- See interior drawer dimensions below

**DRAWER SUSPENSIONS AND FILING**

- File drawers have full extension, progressive action slides with precision steel ball bearings
- Box drawers have ¾ extension slides with ball bearing rollers
- All suspensions have a lifetime warranty
- Heavy duty file rods in file drawers
- See filing capabilities below

**CORD MANAGEMENT**

- Standard in U Bridge, Executive L Return, Highback Organizer, and Credenzas
- Optional wire managers are available (see accessory pages)

**LOCKING**

- Standard locking on all pedestals
- Highback organizers with wood doors feature one standard lock for center compartment
- Black, removable cores are standard for all pedestal locks
- Pedestal key numbers are randomly assigned (1-5) to all locking pedestals; units with multiple pedestals will be keyed alike
- For key specific lock cores, change keys, and master keys reference page 429

Drawer Description	Interior Dimensions Width	Depth	Height	Front-To-Back Filing Capabilities
Box Drawer—Desk	12 <sup>1</sup> / <sub>16</sub> "	17"	3 <sup>1</sup> / <sub>8</sub> "	N/A
File Drawer—Desk	12 <sup>1</sup> / <sub>16</sub> "	17"	9 <sup>1</sup> / <sub>2</sub> "	Letter
Box Drawer—Return	12 <sup>1</sup> / <sub>16</sub> "	17"	3 <sup>1</sup> / <sub>8</sub> "	N/A
File Drawer—Return	12 <sup>1</sup> / <sub>16</sub> "	17"	9 <sup>1</sup> / <sub>2</sub> "	Letter
Box Drawer—Credenza	15 <sup>1</sup> / <sub>16</sub> "	17"	3 <sup>1</sup> / <sub>8</sub> "	N/A
File Drawer—Credenza	15 <sup>1</sup> / <sub>16</sub> "	17"	9 <sup>1</sup> / <sub>2</sub> "	Legal
File Drawer—Lateral File	31 <sup>1</sup> / <sub>32</sub> "	15"	9 <sup>1</sup> / <sub>2</sub> "	Letter/Letter, Letter/Legal, Legal/Legal or Letter/EDP

- All file drawers file letter, legal and EDP side-to-side.

# Zetro – Veneer

For accessory information,  
see pages 423-438.

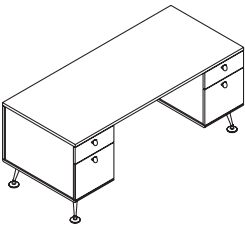
Double Pedestal Desk ¾ Pedestal	Model No.	Description	US Price	Dimensions					Cartoned Weight	Cubic Feet
				D	W	H	A	KW		
	63N3672DDQ3		\$ 1786	35¾	71¾	30¾	3	39½	280 lbs.	39.2
	63N3066DDQ3		1718	29⅞	65¾	30¾	3	33½	258 lbs.	30.5

- Legs must be field installed

## Table Desk

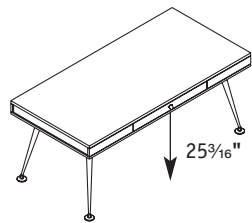

			D	W	H		
63N3672DT	\$ 1571		35¾	71¾	30¾		143 lbs. 11.7

- Unit features a functional, non-locking drawer
- Legs must be field installed

## Single Pedestal Desk ¾ Pedestal

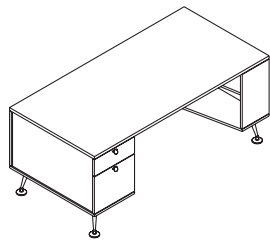

Left Pedestal Desk—¾ Pedestal			D	W	H	A	KW		
63N3672DLQ3	\$ 1756		35¾	71¾	30¾	3	39½	270 lbs.	39.2
63N3066DLQ3	1666		29⅞	65¾	30¾	3	33½	248 lbs.	30.5

Right Pedestal Desk—¾ Pedestal			D	W	H	A	KW		
63N3672DRQ3	\$ 1756		35¾	71¾	30¾	3	39½	270 lbs.	39.2
63N3066DRQ3	1666		29⅞	65¾	30¾	3	33½	248 lbs.	30.5

- Standard bookcase end includes bottom shelf and standard fixed shelf
- Fixed shelf is 12" from bottom shelf
- Legs must be field installed

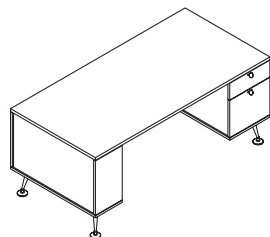

### Finish Key

MH Mocha  
 CW Cordovan  
 MC Amber  
 AC Autumn  
 HN Honey

### To Order, Specify:

1. Model Number  
 2. Finish Designator

### Sample Order Number:

63N3672DDQ3 / CW  
 Model No.      Finish

### Dimension Key

D Depth  
 W Width  
 H Height  
 A Overhang: Approach Side  
 KW Kneespace Width

### Single Pedestal Studio Desk

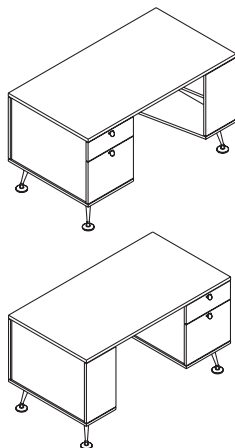

Model No.	Description	US Price	Dimensions					Cartoned Weight	Cubic Feet
<b>Left Pedestal Desk</b>									
			D	W	H	A	KW		
63N3054DLQ		\$ 1552	29 <sup>3</sup> / <sub>4</sub>	53 <sup>3</sup> / <sub>4</sub>	30 <sup>3</sup> / <sub>8</sub>	1 <sup>1</sup> / <sub>16</sub>	26	230 lbs.	25.1
<b>Right Pedestal Desk</b>									
			D	W	H	A	KW		
63N3054DRQ		\$ 1552	29 <sup>3</sup> / <sub>4</sub>	53 <sup>3</sup> / <sub>4</sub>	30 <sup>3</sup> / <sub>8</sub>	1 <sup>1</sup> / <sub>16</sub>	26	230 lbs.	25.1

- Standard bookcase end includes bottom shelf and standard fixed shelf
- Fixed shelf is 12" from bottom shelf
- Legs must be field installed
- Modesty panel features the chassis finish

### U-Shaped Desk

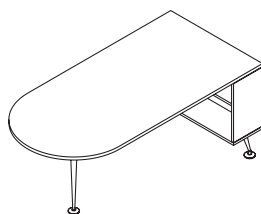

Model No.	US Price	D	W	H	Cartoned Weight	Cubic Feet
63N3672DU	\$ 1283	35 <sup>3</sup> / <sub>4</sub>	71 <sup>3</sup> / <sub>4</sub>	30 <sup>3</sup> / <sub>8</sub>	134 lbs.	.39.2

- Support base included
- Standard bookcase end includes bottom shelf and standard fixed shelf
- Fixed shelf is 12" from bottom shelf
- Legs must be field installed
- End panel features galvanized steel applique
- Not recommended as a freestanding unit

### Executive Return ¾ Pedestal

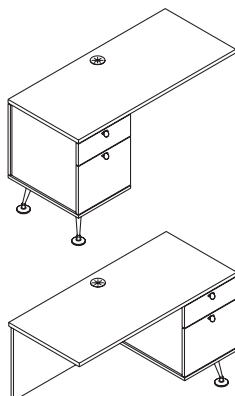

Left Return		D	W	H	A	KW	Cartoned Weight	Cubic Feet
63N2248RLEQ3	\$ 1060	22 <sup>1</sup> / <sub>4</sub>	47 <sup>3</sup> / <sub>4</sub>	30 <sup>3</sup> / <sub>8</sub>	1 <sup>1</sup> / <sub>16</sub>	31 <sup>5</sup> / <sub>8</sub>	127 lbs.	18.4
Right Return		D	W	H	A	KW	Cartoned Weight	Cubic Feet
63N2248RREQ3	\$ 1060	22 <sup>1</sup> / <sub>4</sub>	47 <sup>3</sup> / <sub>4</sub>	30 <sup>3</sup> / <sub>8</sub>	1 <sup>1</sup> / <sub>16</sub>	31 <sup>5</sup> / <sub>8</sub>	127 lbs.	18.4

- Grain direction runs front to back on surfaces
- Legs must be field installed
- Modesty panel features the chassis finish
- End panel features galvanized steel applique

# Zetro – Veneer

For accessory information,  
see pages 423-438.

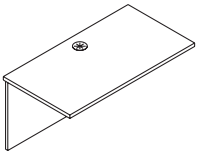
Bridge	Model No.	Description	US Price	Dimensions					Cartoned Weight	Cubic Feet
				D	W	H	A	KW		
	63N2242BEQ		\$ 407	22¼	41¾	30⅞	½	41¾	42 lbs.	3.0
	<ul style="list-style-type: none"> <li>• Some assembly required</li> <li>• Grain direction runs front to back on the worksurface</li> <li>• Bridge has standard center grommet on surface</li> <li>• Modesty panel features the surface finish</li> </ul>									

## Storage Credenza ¾ Pedestal

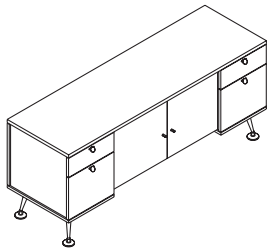

Model No.	Description	US Price	Dimensions					Cartoned Weight	Cubic Feet
			D	W	H	A	KW		
63N2272CSY3		\$ 1786	22¼	71¾	30⅞	1¼ <sub>16</sub>	280 lbs.	27.2	
63N2266CSY3		1724	22¼	65¾	30⅞	1¼ <sub>16</sub>	270 lbs.	25.0	
<ul style="list-style-type: none"> <li>• Legs must be field installed</li> <li>• Adjustable laminate shelf included in unit</li> </ul>									

## Kneespace Credenza ¾ Pedestal

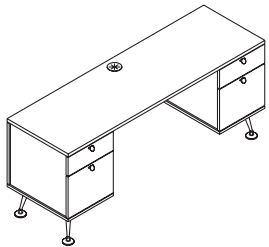

Model No.	Description	US Price	Dimensions					Cartoned Weight	Cubic Feet
			D	W	H	A	KW		
63N2272CKQ3		\$ 1694	22¼	71¾	30⅞	1¼ <sub>16</sub>	39½	269 lbs.	27.2
63N2266CKQ3		1627	22¼	65¾	30⅞	1¼ <sub>16</sub>	33½	257 lbs.	25.0
<ul style="list-style-type: none"> <li>• Legs must be field installed</li> </ul>									

Zetro Veneer

### Finish Key

MH Mocha  
 CW Cordovan  
 MC Amber  
 AC Autumn  
 HN Honey

### To Order, Specify:

1. Model Number  
 2. Finish Designator

### Sample Order Number:

63N2242BEQ / MC  
 Model No.      Finish

### Dimension Key

D Depth  
 W Width  
 H Height  
 A Overhang: Approach Side  
 KW Kneespace Width

### Single Pedestal Credenza ¾ Pedestal

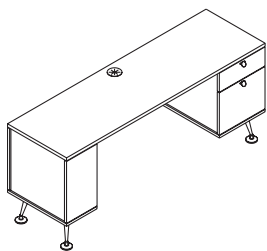
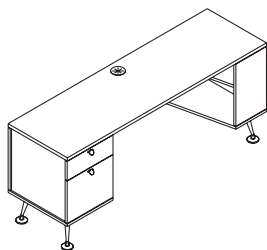

Model No.	Description	US Price	Dimensions					Cartoned Weight	Cubic Feet
<b>Left Pedestal Credenza</b>			D	W	H	A	KW		
63N2272CLQ3		\$ 1384	22¼	71¾	30⅞	1¼	39½	259 lbs.	27.2
63N2266CLQ3		1354	22¼	65¾	30⅞	1¼	33½	247 lbs.	25.0
<b>Right Pedestal Credenza</b>			D	W	H	A	KW		
63N2272CRQ3		\$ 1384	22¼	71¾	30⅞	1¼	39½	259 lbs.	27.2
63N2266CRQ3		1354	22¼	65¾	30⅞	1¼	33½	247 lbs.	25.0

- Standard bookcase end includes bottom shelf and standard fixed shelf
- Fixed shelf is 12" from bottom shelf
- Legs must be field installed

### Highback Organizer

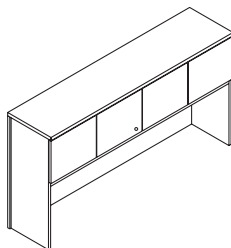
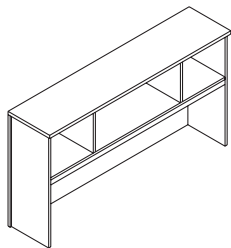

<b>Open Highback Organizer</b>		D	W	H		
63N1572HBE	\$ 1500	14⅝	71⅝	36	200 lbs.	31.5
63N1566HBE	1441	14⅝	65⅝	36	159 lbs.	29.0
<b>Highback Organizer with Wood Doors</b>		D	W	H		
63N1572HBHW4	\$ 1561	14⅝	71⅝	36	220 lbs.	31.5
63N1566HBHW4	1500	14⅝	65⅝	36	175 lbs.	29.0

- Field installed platinum finish door kit can be purchased separately (see page 195)
- End and back panels feature chassis finish
- 63N1572HBE Interior Dimensions      Center Opening 13¼"D x 34¼"W x 12½"H  
 Outside Openings 13¼"D x 15⅞"W x 12½"H
- 63N1566HBE Interior Dimensions      Center Opening 13¼"D x 31⅞"W x 12½"H  
 Outside Openings 13¼"D x 14⅞"W x 12½"H

- Tackboards shown on page 437
- End and back panels feature chassis finish

# Zetro – Veneer

For accessory information,  
see pages 423-438.

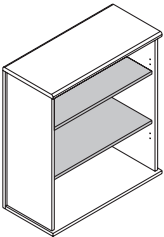
Bookcase Set-On	Model No.	Description	US Price	Dimensions			Cartoned Weight	Cubic Feet
				D	W	H		
	63N1536BCO		\$ 827	14 <sup>5</sup> / <sub>8</sub>	34 <sup>5</sup> / <sub>8</sub>	36	98 lbs.	14.2
	<ul style="list-style-type: none"> <li>• Unit features two adjustable shelves</li> <li>• Field installed platinum door kit can be purchased separately (see page 195)</li> <li>• End and back panels feature chassis finish</li> </ul>							

## Storage Cubby Box

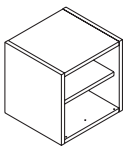
	NAC1313MCBG		\$ 152	D	W	H	22 lbs.	2.2
				13 <sup>3</sup> / <sub>8</sub>	13 <sup>3</sup> / <sub>8</sub>	13 <sup>3</sup> / <sub>8</sub>		
<ul style="list-style-type: none"> <li>• Available in galvanized color (vinyl material) only</li> <li>• Field installed platinum door kit can be purchased separately (see page 195)</li> <li>• Wall mount bracket and kit can be purchased separately (see items below)</li> </ul>								
	NAC72WME	Cubby Mounting Bracket	\$ 70	W			6 lbs.	0.11
			72					
<ul style="list-style-type: none"> <li>• Bracket can be cut-to size in field</li> <li>• Required for wall mount application</li> <li>• National recommends that each overhead cabinet be secured by a minimum of two mounting locations (studs); National will not be liable for wall mount cabinets that are not properly installed</li> </ul>								
	NACMCBMK	Cubby Mounting Kit	\$ 38				2 lbs.	0.5
<ul style="list-style-type: none"> <li>• Required to mount Storage Cubby Box to mounting bracket</li> <li>• Required for wall mount application</li> <li>• One kit required per Storage Cubby Box</li> </ul>								

### Finish Key

MH Mocha  
 CW Cordovan  
 MC Amber  
 AC Autumn  
 HN Honey

### To Order, Specify:

1. Model Number
2. Finish Designator

### Sample Order Number:

63N1536BCO / MC  
 \                      \  
 Model No.          Finish

### Dimension Key

D      Depth  
 W      Width  
 H      Height  
 A      Overhang: Approach Side  
 KW     Kneespace Width

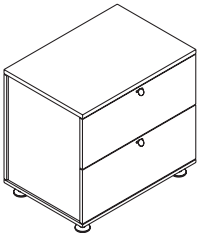
Lateral File	Model No.	Description	US Price	Dimensions			Cartoned Weight	Cubic Feet
				D	W	H		
	63N2236LFF2		\$ 1122	22¼	34⅝	30⅝	184 lbs.	17.8

- Legs must be field installed
- Back panel features chassis finish

### Door Kits

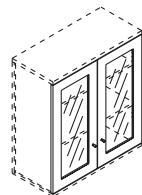
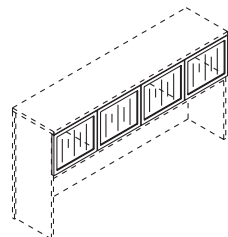

<b>1572 Highback Organizer Platinum Door Kit</b>			
NAC1572HDKA1S	\$ 302		21 lbs. 1.2
<b>1566 Highback Organizer Platinum Door Kit</b>			
NAC1566HDKA1S	\$ 302		19 lbs. 1.0
<b>1536 Set On Bookcase Platinum Door Kit</b>			
NAC1536HDKA1S	\$ 201		15 lbs. 1.2
<b>Storage Cubby Box Platinum Door Kit</b>			
NAC1313HDKA1S	\$ 75		3 lbs. 1.0

- Hinges and pulls included with all door kits

